



KLAUER

MANUFACTURING CO.



FLASHING

FLASHING

› Available Materials for Roof Edges, Drip Edges and Other Flashing Products	4	› Angle Flashing	12
› Style A Roof Edge (Available in Woodgrain Embossed)	4	› Angle Flashing With Hemmed Edges	12
› Style C and CC Roof Edge	4	› Angle Flashing With Lip (Turn Back)	13
› Style D Roof Edge and D Eaves Drip	5	› Inside Angle Flashing	13
› Style L and LL Roof Edge	5	› Inside Angle Flashing With Hemmed Edges	14
› Style SR and SROLL Roof Edge and Eaves Drip	6	› Style W Formed Valley	14
› Gutter Apron With Hemmed Edges	6	› Kick-Out Flashing	14
› T Roof Trim	7	› Flashing Shingles	15
› Gravel Stop and Modified Roof Edge	7	› Available Materials for Trim Coil, Roll Valley and Shingle	16
› Roof Starters	8	› Galvanized and Painted Steel Roll Valley	16-17
› Window Capping	8	› Economy Galvanized Roll Valley	17-18
› Base Flashing (Z Flashing)	9	› Standard Aluminum Roll Valley	19
› Dormer Flashing	9	› Economy Aluminum Roll Valley	20-21
› Deck, Chimney (Reglet) and Counter Flashing	10-11	› Flat Sheets	21
› Rain Diverter With Return	11	› Flashing Collection	22-23
		› Directory	24-43



LIMITED-LIFETIME WARRANTY!

Quality products backed by excellent support.

THE FINISHING TOUCH OF FLASHING

Offering products produced from both steel and aluminum, we bring you the most complete line of residential flashing products in the industry. Available painted finishes include a two-coat, baked-on polyester enamel paint for years of worry-free service and minimal maintenance, complete with a 40-year warranty. They are also resistant to corrosion, fading and chalking while providing excellent color retention. Offering all the shapes and sizes used nationwide, we are your source for every flashing product you need. Custom and specialty products are available upon request.

BENEFITS OF FLASHING

The most pervasive and difficult-to-control weather element threatening your roof is water. Made from durable, low-maintenance materials, Klauer flashing options help mitigate the risk of water damage to susceptible areas like roof valleys, chimneys, eaves, skylights, ridges and more. Extend the life of your roof while giving your home a great finishing touch by taking advantage of the following top-quality products:

- › Roof edges
- › Gutter apron
- › Valley metal
- › Flashing shingles
- › Window cap
- › Z flashing
- › Reglets
- › Dormer flashing
- › Many more

AVAILABLE MATERIALS FOR ROOF EDGES, DRIP EDGES AND OTHER FLASHING PRODUCTS

STEEL:	26 Ga.	(.020)	Thickness	Painted and Bare Galvanized
	29 Ga.	(.015)	Thickness	Painted and Bare Galvanized
	32 Ga.	(.012)	Thickness	Painted and Bare Galvanized
	34 Ga.	(.010)	Thickness	Painted and Bare Galvanized
PAINTED ALUMINUM:	—	(.017)	Thickness	
	—	(.012)	Thickness	
BARE ALUMINUM:	—	(.012)	Thickness	

Klauer flashing material type and color availability vary by product and geographic region. Minimum order quantities may apply to non-standard materials and colors. Please contact your Klauer representative for availability in your area.

STYLE A ROOF EDGE (AVAILABLE IN WOODGRAIN EMBOSSED)

DIAGRAM 4-1

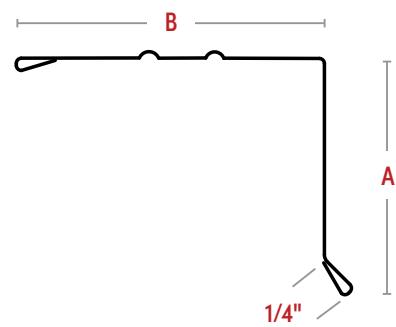

PRODUCT DESCRIPTION	PIECES PER		DIMENSIONS	
	STEEL	ALUMINUM	A	B
1" x 2" Style A Roof Edge - 10'	50	50	1"	2"
1" x 4" Style A Roof Edge - 10'	25	N/A	1"	4"
1-1/2" x 1-1/2" Style A Roof Edge - 10'	50	50	1-1/2"	1-3/8"
2" x 2" Style A Roof Edge - 10'	25	25	2"	1-5/8"
2" x 4" Style A Roof Edge - 10'	25	25	2"	3-7/8"
3" x 3" Style A Roof Edge - 10'	25	N/A	3"	2-7/8"
4" x 4" Style A Roof Edge - 10'	10	10	4"	3-7/8"

Please see Roof Edge Product Directory for more information.

STYLE C AND CC ROOF EDGE

DIAGRAM 4-2

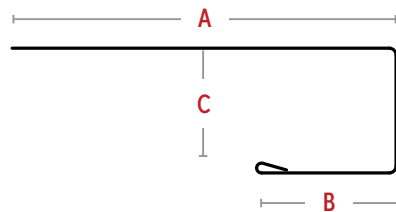

PRODUCT DESCRIPTION	PIECES PER		DIMENSIONS		
	STEEL	ALUMINUM	A	B	C
5" Style C Roof Edge - 10'	25	25	3"	1"	1"
5" Style CC Roof Edge - 10'	25	25	2-1/2"	1"	1-1/2"
6" Style CC Roof Edge - 10'	25	25	3-1/2"	1"	1-1/2"

Please see Roof Edge Product Directory for more information.

STYLE D ROOF EDGE AND D EAVES DRIP

DIAGRAM 5-1

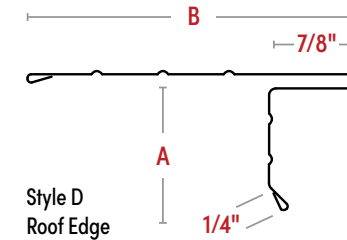

PRODUCT DESCRIPTION	PIECES PER		DIMENSIONS	
	STEEL	ALUMINUM	A	B
4-1/2" Style D Roof Edge - 10'	25	50	1-1/4"	2-3/8"
5" Style D Roof Edge - 10'	25	N/A	1-1/4"	2-7/8"
5-1/2" Style D Roof Edge - 10'	25	50	1-1/4"	3-1/8"
6" Style D Roof Edge - 10'	25	50	2"	2-5/8"
8" Style D Roof Edge - 10'	20	N/A	1-1/4"	5-7/8"
4-1/2" Eaves Drip - 10'	25	50	—	—
8" Eaves Drip - 10'	N/A	50	—	—

DIAGRAM 5-2

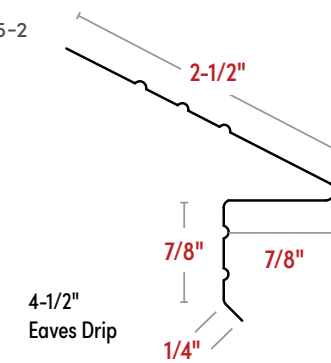
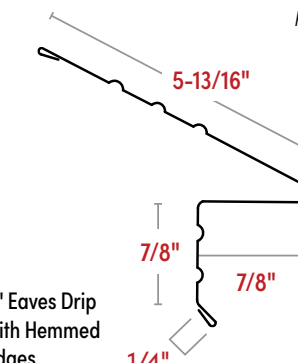

DIAGRAM 5-3



Please see Roof Edge Product Directory for more information.

STYLE L AND LL ROOF EDGE

DIAGRAM 5-4

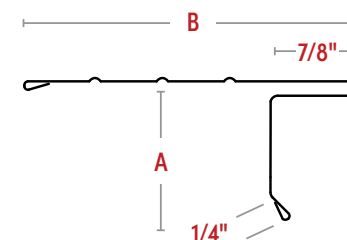

PRODUCT DESCRIPTION	PIECES PER		DIMENSIONS	
	STEEL	ALUMINUM	A	B
5-1/2" Style L Roof Edge - 10'	25	50	1-3/4"	2-1/2"
5-1/2" Style LL Roof Edge - 26 Ga. - 10'	25	N/A	2"	2-1/4"
6" Style L Roof Edge - 10'	N/A	50	1-3/4"	3"
6" Style LL Roof Edge - 10'	25	N/A	2"	2-3/4"

Please see Roof Edge Product Directory for more information.

STYLE SR AND SRLL ROOF EDGE AND EAVES DRIP

DIAGRAM 6-1

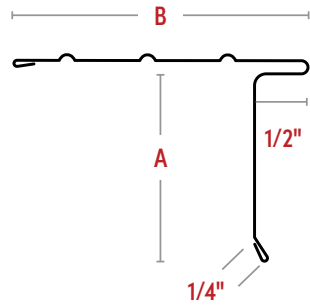

PRODUCT DESCRIPTION	PIECES PER		DIMENSIONS	
	STEEL	ALUMINUM	A	B
4-1/2" Style SR Roof Edge – 10'	25	50	1-3/8"	2-1/4"
5" Style SR Roof Edge – 10'	25	50	1-3/8"	2-3/4"
5" Style SRLL Roof Edge – 10'	25	50	1-3/4"	2-1/4"
5-1/2" Style SRLL Roof Edge – 10'	25	50	1-3/4"	2-3/4"
5" Style SRLL Eaves Drip – 10'	25	50	1-3/4"	2-1/4"
5-1/2" Style SRLL Eaves Drip – 10'	25	50	1-3/4"	2-3/4"
6" Style SRLL Roof Edge – 10'	25	50	1-3/4"	3-1/4"

Please see Roof Edge Product Directory for more information.

DIAGRAM 6-2

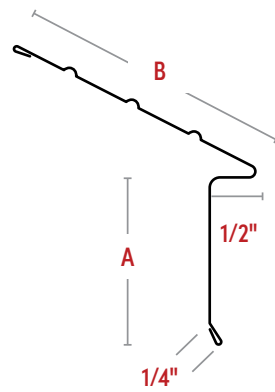

GUTTER APRON WITH HEMMED EDGES

DIAGRAM 6-3

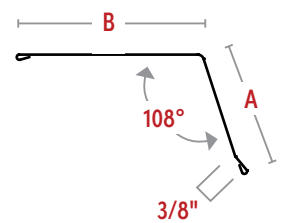

PRODUCT DESCRIPTION	PIECES PER		DIMENSIONS	
	STEEL	ALUMINUM	A	B
2" x 3" Gutter Apron – 10'	25	25	1-7/8"	2-3/4"
3" x 3" Gutter Apron – 10'	25	N/A	2-7/8"	2-3/4"
2" x 4" Gutter Apron – 10'	25	N/A	1-7/8"	3-3/4"
6" Style D-GA Gutter Apron – No Hems – 10'	25	25	–	–

Please see Gutter Apron Product Directory for more information.

DIAGRAM 6-4

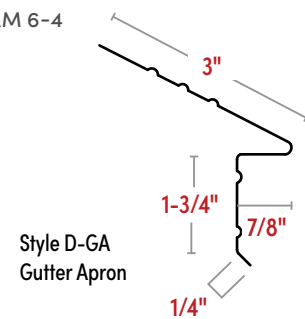

T ROOF TRIM

DIAGRAM 7-1

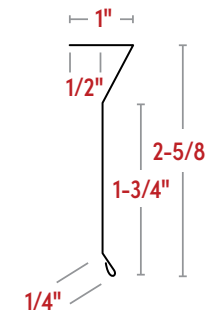

PRODUCT DESCRIPTION	PIECES PER	
	STEEL	ALUMINUM
T Roof Trim – 12'	N/A	25

Please see Roof Edge Product Directory for more information.

GRAVEL STOP AND MODIFIED ROOF EDGE

DIAGRAM 7-2

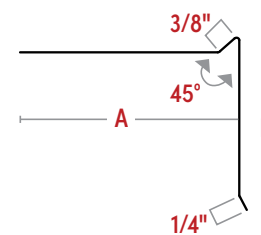
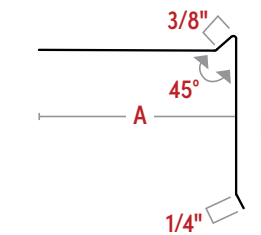
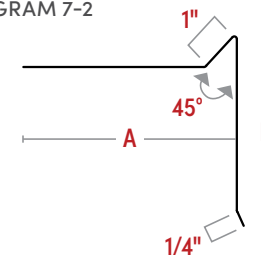

PRODUCT DESCRIPTION	PIECES PER		DIMENSIONS	
	STEEL	ALUMINUM	A	B
5" Girth Gravel Stop – 10'	10	N/A	2"	2-1/4"
7" Girth Gravel Stop – 10'	10	N/A	3"	3-1/4"
8" Girth Gravel Stop – 10'	10	N/A	3-1/4"	3-3/4"
10" Girth Gravel Stop – 10'	10	N/A	4-3/4"	4-1/4"

6" Modified Roof Edge	10	N/A	3-5/8"	2-1/4"
-----------------------	----	-----	--------	--------

7-1/2" Modified Roof Edge	10	N/A	4-1/8"	3-1/4"
---------------------------	----	-----	--------	--------

Please see Gravel Stop and Modified Roof Edge Product Directory for more information.

ROOF STARTERS

DIAGRAM 8-1

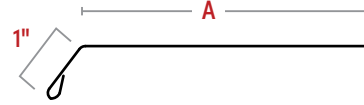

PRODUCT DESCRIPTION	PIECES PER	DIMENSIONS A
6" Roof Starter – 10'	10	4-3/4"

Please see Roof Edge Product Directory for more information.

WINDOW CAPPING

DIAGRAM 8-2

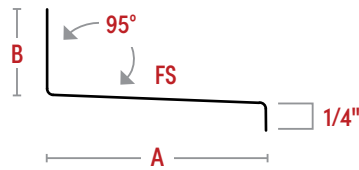

PRODUCT DESCRIPTION	PIECES PER		DIMENSIONS	
	STEEL	ALUMINUM	A	B
1-1/6" Header Window Capping – 10'	50	50	1-1/16"	1-3/4"
1-1/4" Header Window Capping – 10'	50	50	1-1/4"	1-1/2"
1-3/8" Header Window Capping – 10'	50	50	1-3/8"	1-3/8"
1-1/2" Header Window Capping – 10'	50	50	1-1/2"	1-1/2"
1-5/8" Header Window Capping – 10'	50	50	1-5/8"	1-1/2"
1-3/4" Header Window Capping – 10'	50	50	1-3/4"	1-1/2"
1" Header Window Capping 2" Back Leg – 10'	50	50	1"	2"
1-1/8" Header Window Capping 2" Back Leg – 10'	50	50	1-1/8"	2"
1-1/4" Header Window Capping 2" Back Leg – 10'	50	50	1-1/4"	2"
1-3/8" Header Window Capping 2" Back Leg – 10'	50	50	1-3/8"	2"
1-3/4" Header Window Capping 2" Back Leg – 10'	50	50	1-3/4"	2"

Please see Window Capping Product Directory for more information.

BASE FLASHING (Z FLASHING)

DIAGRAM 9-1

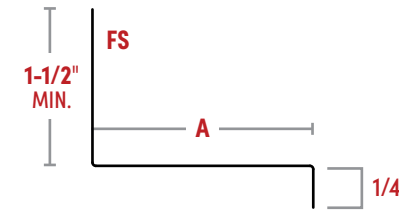

PRODUCT DESCRIPTION	PIECES PER		DIMENSIONS A
	STEEL	ALUMINUM	
3/8" Base Flashing – 10'	25	50	3/8"
7/16" Base Flashing – 10'	25	50	7/16"
1/2" Base Flashing – 10'	25	50	1/2"
5/8" Base Flashing – 10'	25	50	5/8"
3/4" Base Flashing – 10'	25	50	3/4"
1" Base Flashing – 10'	25	50	1"
1-1/8" Base Flashing – 10'	25	50	1-1/8"
1-3/4" Base Flashing – 10'	25	50	1-3/4"

Please see Base Flashing Product Directory for more information.

DORMER FLASHING

DIAGRAM 9-2

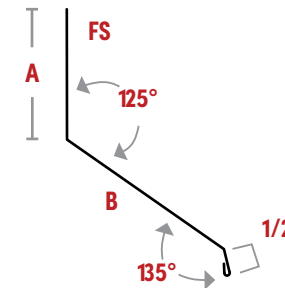

PRODUCT DESCRIPTION	PIECES PER	DIMENSIONS	
		A	B
#2220 Dormer Flashing – 10'	10	3-3/4"	5"
#13720 Dormer Flashing – 10'	10	3-1/2"	4-1/2"

Please see Dormer Flashing Product Directory for more information.

DECK, CHIMNEY (REGLET) AND COUNTER FLASHING

DIAGRAM 10-1

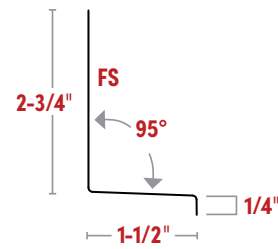

PART NUMBER	PRODUCT DESCRIPTION	PIECES PER
86450	#2401 Deck Flashing – 10'	25

DIAGRAM 10-2

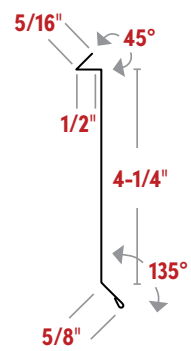
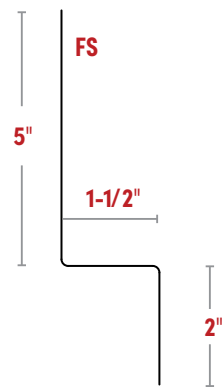

DIAGRAM 10-3



88820	4-1/4" Reglet – with Return – 10'	10
88830	4-1/4" Reglet – without Return – 10'	10

DIAGRAM 10-4



85830	#2330 Deck-Starter Strip – 10'	25
-------	--------------------------------	----

Please see Deck, Chimney (Reglet) and Counter Flashing Product Directory for more information.

continued

DECK, CHIMNEY (REGLET) AND COUNTER FLASHING

continued

DIAGRAM 11-1

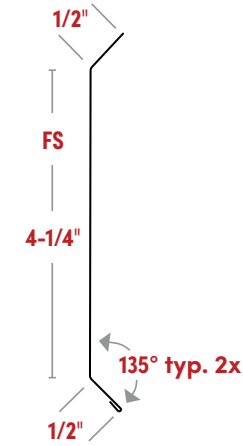

PART NUMBER	PRODUCT DESCRIPTION	PIECES PER
88822	4-1/4" Counter Flashing – 10'	10

DIAGRAM 11-2

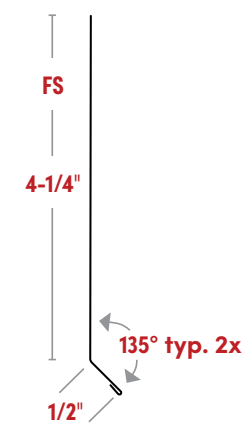

88824	4-1/4" Counter Flashing without Lip – 10'	10
-------	---	----

Please see Deck, Chimney (Reglet) and Counter Flashing Product Directory for more information.

RAIN DIVERTER WITH RETURN

DIAGRAM 11-3

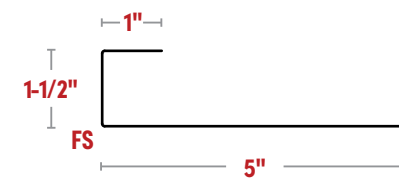

PART NUMBER	PRODUCT DESCRIPTION	PIECES PER
85440	#2277 7-1/2" Rain Diverter – 10'	10

Please see Rain Diverter With Return Product Directory for more information.

ANGLE FLASHING

DIAGRAM 12-1

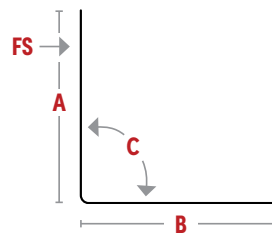

PRODUCT DESCRIPTION	PACKAGING PER	DIMENSIONS		
		A	B	C
1-1/2" x 4-1/2" Angle Flashing 100 Degrees – Wrap 10'	10	1-1/2"	4-1/2"	100°
1-1/2" x 1-1/2" Angle Flashing – Wrap 12'	10	1-1/2"	1-1/2"	90°
2" x 2" Angle Flashing – Wrap 10'	10	2"	2"	90°
2" x 2" Angle Flashing 100 Degrees – Wrap 10'	100	2"	2"	100°
2-1/2" x 2-1/2" Angle Flashing – Wrap 10'	10	2-1/2"	2-1/2"	90°
3" x 3" Angle Flashing – Wrap 10'	25	3"	3"	90°
3"x3" Angle Flashing 110 Degrees with One 1/2" Flat Hem – Wrap 10'	10	3"	3"	110°
3" x 4" Angle Flashing – Wrap 10'	10	3"	4"	90°
3" x 5" Angle Flashing – Wrap 10'	10	3"	5"	90°
4" x 3-1/2" Angle Flashing – Wrap 10'	10	4"	3-1/2"	90°
4" x 4" Angle Flashing 120 Degrees – Wrap 10'	10	4"	4"	120°
4" x 5" Angle Flashing – Ctn 10'	10	4"	5"	90°
4" x 5" Angle Flashing 120 Degrees – Wrap 10'	10	4"	5"	120°
4" x 6" Angle Flashing – Wrap 10'	10	4"	6"	90°
5" x 5" Angle Flashing – Wrap 10'	10	5"	5"	90°
5" x 5" Angle Flashing 120 Degrees – Wrap 10'	10	5"	5"	120°
6" x 6" Angle Flashing – Ctn 10'	10	6"	6"	90°

Please see Angle Flashing Product Directory for more information.

ANGLE FLASHING WITH HEMMED EDGES

DIAGRAM 12-2

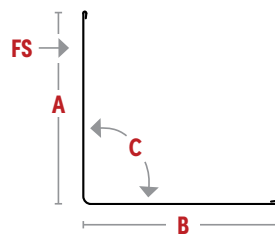

PRODUCT DESCRIPTION	PACKAGING PER	DIMENSIONS		
		A	B	C
1" x 3" Angle Flashing with Hems – Wrap 10'	10	1"	3"	90°
1-1/2" x 2-1/2" Angle Flashing with Hems – Wrap 10'	10	1-1/2"	2-1/2"	90°
1-1/2" x 1-1/2" Angle Flashing with Hems – Wrap 10'	10	1-1/2"	1-1/2"	90°
2" x 2" Angle Flashing with Hems – Wrap 10'	10	2"	2"	90°
2" x 3" Angle Flashing with Hems – Wrap 10'	10	2"	3"	90°
2-1/2" x 2-1/2" Angle Flashing with Hems – Wrap 12' 1"	10	2-1/2"	2-1/2"	90°
3" x 3" Angle Flashing with Hems – Wrap 10'	10	3"	3"	90°
3" x 3" Angle Flashing 120 Degrees with Hems – Wrap 10'	10	3"	3"	120°
3" x 5" Angle Flashing with Hems – Wrap 10'	10	3"	5"	90°
4" x 4" Angle Flashing with Hems – Wrap 10'	10	4"	4"	90°
5" x 5" Angle Flashing with Hems – Wrap 10'	10	5"	5"	90°
6" x 6" Angle Flashing with Hems – Wrap 10'	10	6"	6"	90°

Please see Angle Flashing Product Directory for more information.

ANGLE FLASHING WITH LIP (TURN BACK)

DIAGRAM 13-1

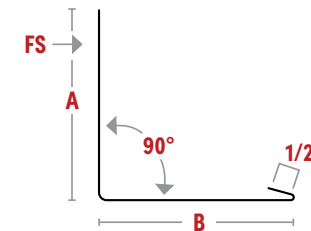

PRODUCT DESCRIPTION	PACKAGING PER	DIMENSIONS	
		A	B
4" x 3-1/2" Angle Flashing with Lip – Wrap 10'	10	4"	3-1/2"
4" x 4" Angle Flashing with Lip – Bulk Pk 10'	500	4"	4"
4" x 5" Angle Flashing with Lip – Wrap 10'	10	4"	5"
6" x 6" Angle Flashing with Lip – Ctn 10'	10	6"	6"

Please see Angle Flashing Product Directory for more information.

INSIDE ANGLE FLASHING

DIAGRAM 13-2

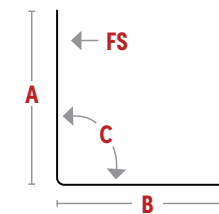

PRODUCT DESCRIPTION	PACKAGING PER	DIMENSIONS		
		A	B	C
3" x 3" Inside Angle Flashing – Wrap 12'	10	3"	3"	90°
4" x 4" Inside Angle Flashing – Wrap 10'	10	4"	4"	90°
4" x 4" Inside Angle Flashing 112 Degrees – Wrap 10'	10	4"	4"	112°
4" x 4" Inside Angle Flashing 120 Degrees – Wrap 10'	10	4"	4"	120°
4" x 6" Inside Angle Flashing – Wrap 10'	10	4"	6"	90°
4" x 6" Inside Angle Flashing 120 Degrees – Wrap 10'	10	4"	6"	120°
4" x 4" Inside Angle Flashing with Reverse Lip – Wrap 10'	10	–	–	–

DIAGRAM 13-3

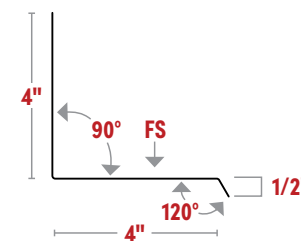
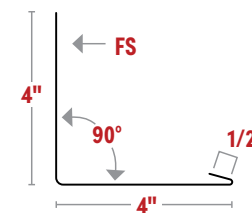

DIAGRAM 13-4



Please see Angle Flashing Product Directory for more information.

INSIDE ANGLE FLASHING WITH HEMMED EDGES

DIAGRAM 14-1

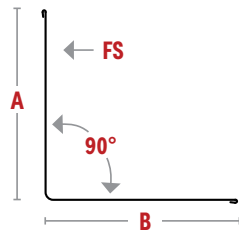

PRODUCT DESCRIPTION	PACKAGING PER	DIMENSIONS	
		A	B
2" x 2" Inside Angle Flashing with Hems – Wrap 10'	25t	2"	2"
4" x 4" Inside Angle Flashing with Hems – Wrap 10'	10	4"	4"
4" x 6" Inside Angle Flashing with Hems – Wrap 10'	10	4"	6"
6" x 6" Inside Angle Flashing with Hems – Wrap 10'	10	6"	6"

Please see Angle Flashing Product Directory for more information.

STYLE W FORMED VALLEY

DIAGRAM 14-2

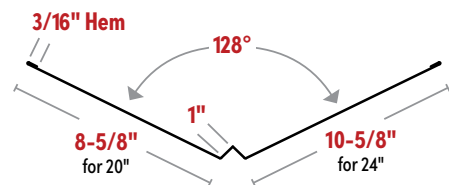

PRODUCT DESCRIPTION	PIECES PER	
	STEEL	ALUMINUM
Style W Formed Valley		
20" Style W Formed Valley – 10'	10	10
24" Style W Formed Valley – 10'	10	10
24" Style W Formed Valley – 26 Ga. – 10'	10	N/A

DIAGRAM 14-3

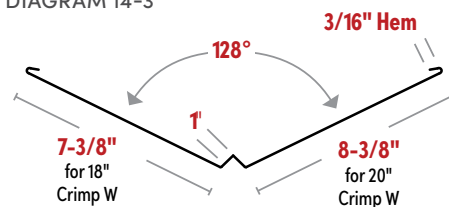

Style W Formed Valley with Crimp		
18" Style W Formed Valley with Crimp – 10'	10	10
20" Style W Formed Valley with Crimp – 10'	10	10

Please see W Valley Product Directory for more information.

KICK-OUT FLASHING

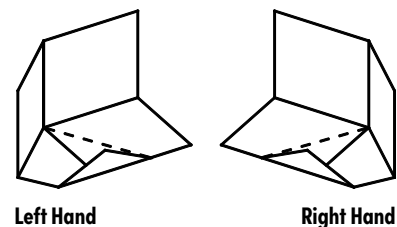

PRODUCT DESCRIPTION	PIECES PER
Left Hand, 4" x 4" x 8" Seamless – 130° Deflection	25
Right Hand, 4" x 4" x 8" Seamless – 130° Deflection	25

Please see Shingles Product Directory for more information.

FLASHING SHINGLES

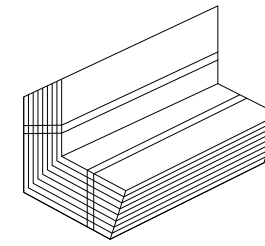

Crimp Shingle

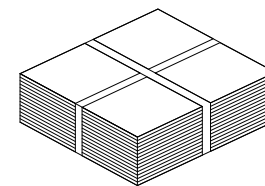

Flat Shingle

PRODUCT DESCRIPTION	PIECES PER	
	STEEL	ALUMINUM
5" x 7" Shingles	100	100
5" x 7" Shingles	N/A	500
2-1/2" x 2-1/2" x 7" Shingles	100	100
2-1/2" x 2-1/2" x 7" Shingles	N/A	500
2" x 3" x 7" Shingles	100	100
2" x 3" x 7" Shingles	N/A	500
6" x 8" Shingles	100	100
3" x 3" x 8" Shingles	100	100
3" x 4" x 7" Shingles	N/A	500
7" x 9" Shingles	100	100
7" x 10" Shingles	N/A	500
8" x 7" Shingles	100	100
8" x 7" Shingles	N/A	500
4" x 4" x 8" Shingles	50	50
8" x 8" Shingles	100	100
8" x 8" Shingles	N/A	500
4" x 4" x 8" Shingles	100	100
4" x 4" x 8" Shingles	N/A	500
8" x 9" Shingles	N/A	500
8" x 10" Shingles	N/A	500
5" x 5" x 8" Shingles	100	100
10" x 10" Shingles	100	100
5" x 5" x 10" Shingles	100	100
8" x 14" Shingles	50	50
4" x 4" x 14" Shingles	50	50

Please see Shingles Product Directory for more information.

AVAILABLE MATERIALS FOR TRIM COIL, ROLL VALLEY AND SHINGLE

STEEL:	Standard	29 Ga.	(.015)	Thickness	Painted Trim Coil
	Standard	29 Ga.	(.015)	Thickness	W Valley, Bare and Painted
	Standard	32 Ga.	(.012)	Thickness	Bare Roll Valley
	Economy	34 Ga.	(.010)	Thickness	Bare Roll Valley
	Standard	32 Ga.	(.012)	Thickness	Shingle, Both Painted and Bare
	Economy	34 Ga.	(.010)	Thickness	Bare Shingles
ALUMINUM:	Standard	—	(.017)	Thickness	Painted Trim Coil
	Standard	—	(.012)	Thickness	Bare Roll Valley
	Economy	—	(.009)	Thickness	Bare Roll Valley
	Standard	—	(.012)	Thickness	Shingle, Both Painted and Bare

GALVANIZED AND PAINTED STEEL ROLL VALLEY

9-roll minimum for all sizes except 24", which can be ordered by the roll.

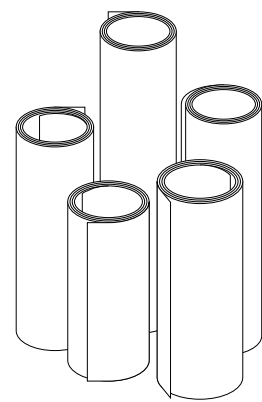

PRODUCT DESCRIPTION	PACKAGING PER PALLET	WEIGHT PER ROLL:	
		GALVANIZED	PAINTED
4" Roll Valley – 50'	100 rolls	8.00 lbs.	10.50 lbs.
4" Roll Valley – 10'	100 rolls	6.60 lbs.	2.10 lbs.
4" Roll Valley – 25'	100 rolls	4.00 lbs.	5.25 lbs.
6" Roll Valley – 50'	100 rolls	12.00 lbs.	16.00 lbs.
6" Roll Valley – 10'	100 rolls	2.40 lbs.	3.20 lbs.
6" Roll Valley – 25'	100 rolls	6.00 lbs.	8.00 lbs.
8" Roll Valley – 50'	150 rolls	15.50 lbs.	22.00 lbs.
8" Roll Valley – 10'	150 rolls	3.10 lbs.	4.40 lbs.
8" Roll Valley – 25'	150 rolls	7.75 lbs.	11.00 lbs.
10" Roll Valley – 50'	125 rolls	19.50 lbs.	27.50 lbs.
10" Roll Valley – 10'	125 rolls	3.90 lbs.	5.50 lbs.
10" Roll Valley – 25'	125 rolls	9.75 lbs.	13.75 lbs.
12" Roll Valley – 50'	100 rolls	23.50 lbs.	32.50 lbs.
12" Roll Valley – 10'	100 rolls	4.70 lbs.	6.50 lbs.
12" Roll Valley – 25'	100 rolls	11.75 lbs.	16.25 lbs.
14" Roll Valley – 50'	100 rolls	27.00 lbs.	37.50 lbs.
14" Roll Valley – 10'	100 rolls	5.40 lbs.	7.50 lbs.
14" Roll Valley – 25'	100 rolls	13.50 lbs.	18.75 lbs.

Please see Roll Valley Product Directory for more information.

continued

GALVANIZED AND PAINTED STEEL ROLL VALLEY

continued

9-roll minimum for all sizes except 24", which can be ordered by the roll.

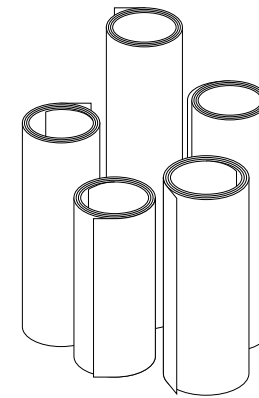

PRODUCT DESCRIPTION	PACKAGING PER PALLET	WEIGHT PER ROLL:	
		GALVANIZED	PAINTED
16" Roll Valley – 50'	75 rolls	31.00 lbs.	43.00 lbs.
16" Roll Valley – 10'	75 rolls	6.20 lbs.	8.60 lbs.
16" Roll Valley – 25'	75 rolls	15.50 lbs.	21.50 lbs.
18" Roll Valley – 50'	75 rolls	35.00 lbs.	48.50 lbs.
18" Roll Valley – 10'	75 rolls	7.00 lbs.	9.70 lbs.
18" Roll Valley – 25'	75 rolls	17.50 lbs.	24.25 lbs.
20" Roll Valley – 50'	50 rolls	38.50 lbs.	54.00 lbs.
20" Roll Valley – 10'	50 rolls	7.70 lbs.	10.80 lbs.
20" Roll Valley – 25'	50 rolls	19.25 lbs.	27.00 lbs.
24" Roll Valley – 50'	50 rolls	46.50 lbs.	65.00 lbs.
24" Roll Valley – 10'	50 rolls	9.30 lbs.	13.00 lbs.
24" Roll Valley – 25'	50 rolls	23.25 lbs.	32.50 lbs.
36" Roll Valley – 50'	25 rolls	70.50 lbs.	98.50 lbs.
36" Roll Valley – 10'	25 rolls	14.10 lbs.	19.70 lbs.
36" Roll Valley – 25'	25 rolls	35.25 lbs.	49.25 lbs.

Please see Roll Valley Product Directory for more information.

ECONOMY GALVANIZED ROLL VALLEY

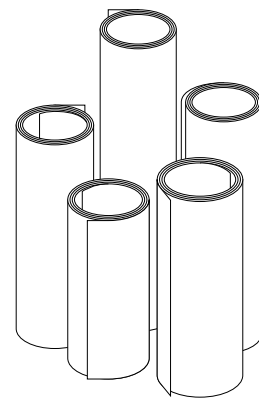

PRODUCT DESCRIPTION	PACKAGING PER PALLET	WEIGHT PER ROLL
4" Roll Valley – 50'	150 rolls	6.80 lbs.
4" Roll Valley – 10'	150 rolls	1.36 lbs.
4" Roll Valley – 25'	150 rolls	3.40 lbs.
6" Roll Valley – 50'	100 rolls	10.20 lbs.
6" Roll Valley – 10'	100 rolls	2.04 lbs.
6" Roll Valley – 25'	100 rolls	5.10 lbs.
8" Roll Valley – 50'	100 rolls	13.39 lbs.
8" Roll Valley – 10'	100 rolls	2.68 lbs.
8" Roll Valley – 25'	100 rolls	6.69 lbs.
10" Roll Valley – 50'	75 rolls	17.00 lbs.
10" Roll Valley – 10'	75 rolls	3.40 lbs.
10" Roll Valley – 25'	75 rolls	8.50 lbs.

Please see Roll Valley Product Directory for more information.

continued

ECONOMY GALVANIZED ROLL VALLEY

continued

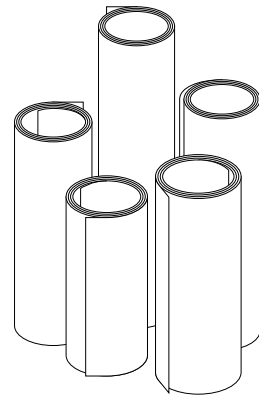

PRODUCT DESCRIPTION	PACKAGING PER PALLET	WEIGHT PER ROLL
12" Roll Valley – 50'	50 rolls	20.19 lbs.
12" Roll Valley – 10'	50 rolls	4.04 lbs.
12" Roll Valley – 25'	50 rolls	10.09 lbs.
14" Roll Valley – 50'	50 rolls	23.37 lbs.
14" Roll Valley – 10'	50 rolls	4.67 lbs.
14" Roll Valley – 25'	50 rolls	11.69 lbs.
16" Roll Valley – 50'	50 rolls	26.77 lbs.
16" Roll Valley – 10'	50 rolls	5.35 lbs.
16" Roll Valley – 25'	50 rolls	13.39 lbs.
18" Roll Valley – 50'	25 rolls	30.17 lbs.
18" Roll Valley – 10'	25 rolls	6.03 lbs.
18" Roll Valley – 25'	25 rolls	15.09 lbs.
20" Roll Valley – 50'	25 rolls	33.57 lbs.
20" Roll Valley – 10'	25 rolls	6.71 lbs.
20" Roll Valley – 25'	25 rolls	16.79 lbs.
24" Roll Valley – 50'	25 rolls	40.37 lbs.
24" Roll Valley – 10'	25 rolls	8.07 lbs.
24" Roll Valley – 25'	25 rolls	20.19 lbs.
36" Roll Valley – 50'	25 rolls	61.19 lbs.
36" Roll Valley – 10'	25 rolls	12.24 lbs.
36" Roll Valley – 25'	25 rolls	30.60 lbs.

Please see Roll Valley Product Directory for more information.

STANDARD ALUMINUM ROLL VALLEY

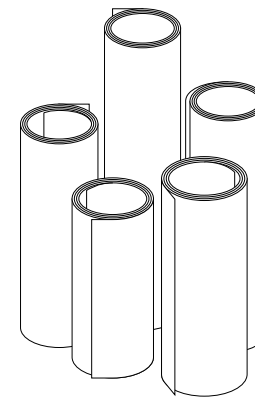

PRODUCT DESCRIPTION	PACKAGING PER PALLET	WEIGHT PER ROLL
4" Standard Aluminum Roll Valley – 50'	100 rolls	2.50 lbs.
4" Standard Aluminum Roll Valley – 10'	100 rolls	.50 lbs.
4" Standard Aluminum Roll Valley – 25'	100 rolls	1.25 lbs.
6" Standard Aluminum Roll Valley – 50'	125 rolls	3.50 lbs.
6" Standard Aluminum Roll Valley – 10'	125 rolls	.70 lbs.
6" Standard Aluminum Roll Valley – 25'	125 rolls	1.75 lbs.
8" Standard Aluminum Roll Valley – 50'	150 rolls	5.00 lbs.
8" Standard Aluminum Roll Valley – 10'	150 rolls	1.00 lb.
8" Standard Aluminum Roll Valley – 25'	150 rolls	2.50 lbs.
10" Standard Aluminum Roll Valley – 50'	125 rolls	6.50 lbs.
10" Standard Aluminum Roll Valley – 10'	125 rolls	1.30 lbs.
10" Standard Aluminum Roll Valley – 25'	125 rolls	3.25 lbs.
12" Standard Aluminum Roll Valley – 50'	100 rolls	7.00 lbs.
12" Standard Aluminum Roll Valley – 10'	100 rolls	1.40 lbs.
12" Standard Aluminum Roll Valley – 25'	100 rolls	3.50 lbs.
14" Standard Aluminum Roll Valley – 50'	100 rolls	8.50 lbs.
14" Standard Aluminum Roll Valley – 10'	100 rolls	1.70 lbs.
14" Standard Aluminum Roll Valley – 25'	100 rolls	4.25 lbs.
16" Standard Aluminum Roll Valley – 50'	75 rolls	9.50 lbs.
16" Standard Aluminum Roll Valley – 10'	75 rolls	1.90 lbs.
16" Standard Aluminum Roll Valley – 25'	75 rolls	4.75 lbs.
18" Standard Aluminum Roll Valley – 50'	75 rolls	10.50 lbs.
18" Standard Aluminum Roll Valley – 10'	75 rolls	2.10 lbs.
18" Standard Aluminum Roll Valley – 25'	75 rolls	5.25 lbs.
20" Standard Aluminum Roll Valley – 50'	50 rolls	12.00 lbs.
20" Standard Aluminum Roll Valley – 10'	50 rolls	2.40 lbs.
20" Standard Aluminum Roll Valley – 25'	50 rolls	6.00 lbs.
24" Standard Aluminum Roll Valley – 50'	50 rolls	14.50 lbs.
24" Standard Aluminum Roll Valley – 10'	50 rolls	2.90 lbs.
24" Standard Aluminum Roll Valley – 25'	50 rolls	7.25 lbs.
36" Standard Aluminum Roll Valley – 50'	25 rolls	22.00 lbs.
36" Standard Aluminum Roll Valley – 10'	25 rolls	4.40 lbs.
36" Standard Aluminum Roll Valley – 25'	25 rolls	11.00 lbs.

Please see Roll Valley Product Directory for more information.

ECONOMY ALUMINUM ROLL VALLEY

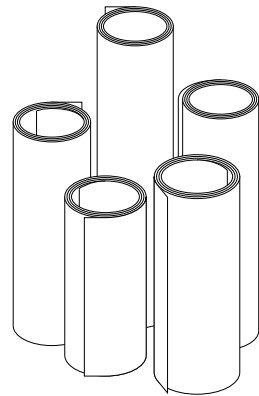

PRODUCT DESCRIPTION	PACKAGING PER PALLET	WEIGHT PER ROLL
4" Economy Aluminum Roll Valley – 50'	100 rolls	2.00 lbs.
4" Economy Aluminum Roll Valley – 10'	100 rolls	.40 lbs.
4" Economy Aluminum Roll Valley – 25'	100 rolls	1.00 lb.
6" Economy Aluminum Roll Valley – 50'	125 rolls	2.00 lbs.
6" Economy Aluminum Roll Valley – 10'	125 rolls	.60 lbs.
6" Economy Aluminum Roll Valley – 25'	125 rolls	1.50 lbs.
8" Economy Aluminum Roll Valley – 50'	150 rolls	4.00 lbs.
8" Economy Aluminum Roll Valley – 10'	150 rolls	.80 lbs.
8" Economy Aluminum Roll Valley – 25'	150 rolls	2.00 lbs.
10" Economy Aluminum Roll Valley – 50'	125 rolls	5.00 lbs.
10" Economy Aluminum Roll Valley – 10'	125 rolls	1.00 lb.
10" Economy Aluminum Roll Valley – 25'	125 rolls	2.50 lbs.
12" Economy Aluminum Roll Valley – 50'	100 rolls	6.00 lbs.
12" Economy Aluminum Roll Valley – 10'	100 rolls	1.20 lbs.
12" Economy Aluminum Roll Valley – 25'	100 rolls	3.00 lbs.
14" Economy Aluminum Roll Valley – 50'	100 rolls	7.00 lbs.
14" Economy Aluminum Roll Valley – 10'	100 rolls	1.40 lbs.
14" Economy Aluminum Roll Valley – 25'	100 rolls	3.50 lbs.
16" Economy Aluminum Roll Valley – 50'	75 rolls	8.00 lbs.
16" Economy Aluminum Roll Valley – 10'	75 rolls	1.60 lbs.
16" Economy Aluminum Roll Valley – 25'	75 rolls	4.00 lbs.
18" Economy Aluminum Roll Valley – 50'	75 rolls	9.00 lbs.
18" Economy Aluminum Roll Valley – 10'	75 rolls	1.80 lbs.
18" Economy Aluminum Roll Valley – 25'	75 rolls	4.50 lbs.

Please see Roll Valley Product Directory for more information.

continued

ECONOMY ALUMINUM ROLL VALLEY

continued

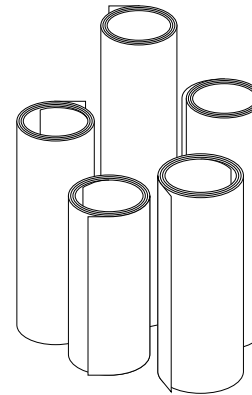

PRODUCT DESCRIPTION	PACKAGING PER PALLET	WEIGHT PER ROLL
20" Economy Aluminum Roll Valley – 50'	50 rolls	10.50 lbs.
20" Economy Aluminum Roll Valley – 10'	50 rolls	2.10 lbs.
20" Economy Aluminum Roll Valley – 25'	50 rolls	5.25 lbs.
24" Economy Aluminum Roll Valley – 50'	50 rolls	12.50 lbs.
24" Economy Aluminum Roll Valley – 10'	50 rolls	2.50 lbs.
24" Economy Aluminum Roll Valley – 25'	50 rolls	6.25 lbs.
36" Economy Aluminum Roll Valley – 50'	25 rolls	19.00 lbs.
36" Economy Aluminum Roll Valley – 10'	25 rolls	3.80 lbs.
36" Economy Aluminum Roll Valley – 25'	25 rolls	9.50 lbs.

Please see Roll Valley Product Directory for more information.

FLAT SHEETS

PRODUCT DESCRIPTION	PIECES PER
29-Ga. Sheet – 36" x 96"	25
29-Ga. Sheet – 36" x 120"	25

FLASHING COLLECTION

TRADITIONAL BUILDING PRODUCTS (STEEL ONLY)



KEY:

* = .015 29 Gauge
 † = .012 32 Gauge
 ‡ = .020 26 Gauge

Premium colors: Brite Red, Copper Canyon and Midnight Blue

Klauer flashing material type and color availability vary by product and geographic region. Minimum order quantities may apply to non-standard materials and colors. Please contact your Klauer representative for availability in your area.

SHERWIN-WILLIAMS.
Coil Coatings

The colors shown are intended only as an approximation of the actual colors. Color chips are available upon request.

FLASHING COLLECTION

continued

KLAUER CLASSIC (ALUMINUM AND STEEL)



*Available in Aluminum only.

KLAUER SELECT (ALUMINUM ONLY)



Dura Coat
PRODUCTS
An Axalta Coating Systems Company

The colors shown are intended only as an approximation of the actual colors. Color chips are available upon request.

Klauer flashing material type and color availability vary by product and geographic region. Minimum order quantities may apply to non-standard materials and colors. Please contact your Klauer representative for availability in your area.

ROOF EDGE PRODUCT DIRECTORY

PART NUMBER	PRODUCT DESCRIPTION	MATERIAL	GAUGE/DECIMAL	QTY. PER	DIAGRAM
31999	1" x 2" Style A Roof Edge – Ctns 10'	Steel	26	50	4-1
32013	1" x 2" Style A Roof Edge – Ctns 10'	Steel	32	50	4-1
31998	1" x 2" Style A Roof Edge – Ctns 10'	Steel	34	25	4-1
32001	1" x 2" Style A Roof Edge – Ctns 10'	Steel	32	25	4-1
32005	1" x 2" Style A Roof Edge – Wrap 10'	Steel	29	50	4-1
32008	1" x 2" Style A Roof Edge – Wrap 10'	Steel	32	50	4-1
32814	1-1/2" x 1-1/2" Style A Roof Edge – Ctns 10'	Steel	32	25	4-1
32803	1-1/2" x 1-1/2" Style A Roof Edge – Ctns 10'	Steel	34	25	4-1
32810	1-1/2" x 1-1/2" Style A Roof Edge – Wrap 10'	Steel	29	50	4-1
32819	1-1/2" x 1-1/2" Style A Roof Edge – Wrap 10'	Steel	29	25	4-1
32812	1-1/2" x 1-1/2" Style A Roof Edge – Wrap 10'	Steel	32	25	4-1
32811	1-1/2" x 1-1/2" Style A Roof Edge – Wrap 10'	Steel	32	50	4-1
32799	1-1/2" x 1-1/2" Style A Roof Edge – Wrap 10'	Steel	34	50	4-1
32811	1-1/2" x 1-1/2" Style A Roof Edge (C-3) (3" Rake Edge) – Wrap 10'	Aluminum	.012	50	4-1
32818	1-1/2" x 1-1/2" Style A Roof Edge (OS No Hem) – Wrap 10'	Aluminum	.012	25	4-1
32823	1-1/2" x 1-1/2" Style A Roof Edge (OS No Hem) – Wrap 10'	Aluminum	.012	50	4-1
32818	1-1/2" x 1-1/2" Style A Roof Edge (OS No Hem) – Wrap 10'	Aluminum	.017	25	4-1
32823	1-1/2" x 1-1/2" Style A Roof Edge (OS No Hem) – Wrap 10'	Aluminum	.017	50	4-1
32818	1-1/2" x 1-1/2" Style A Roof Edge (OS No Hem) – Wrap 10'	Steel	29	25	4-1
32806	1-1/2" x 1-1/2" Style A Roof Edge (OS No Hem) – Wrap 10'	Steel	32	25	4-1
32817	1-1/2" x 1-1/2" Style A Roof Edge (OS No Hem) – Wrap 10'	Steel	32	50	4-1
32809	1-1/2" x 1-1/2" Style A Roof Edge Embossed – Ctns 10'	Steel	32	25	4-1
32808	1-1/2" x 1-1/2" Style A Roof Edge Embossed – Ctns 10'	Steel	32	50	4-1
32007	1-1/2" x 2" Style A Roof Edge – Wrap 10'	Aluminum	.017	50	4-1
31986	1-1/2" x 2" Style A Roof Edge (OS No Hem) – Ctns 10'	Steel	32	25	4-1
32037	1-1/2" x 3" Style A Roof Edge – Wrap 10'	Steel	29	25	4-1
32033	1" x 3-1/2" (C5) Style A Roof Edge – Wrap 10'	Steel	29	25	4-1
32045	2" x 2" Style A Roof Edge – Ctns 10'	Steel	26	25	4-1
32021	2" x 2" Style A Roof Edge – Ctns 10'	Steel	29	25	4-1
32039	2" x 2" Style A Roof Edge – Ctns 10'	Steel	32	25	4-1
32063	2" x 2" Style A Roof Edge – Ctns 10'	Steel	34	25	4-1
32020	2" x 2" Style A Roof Edge – Wrap 10'	Steel	29	25	4-1
32022	2" x 2" Style A Roof Edge – Wrap 10'	Steel	32	25	4-1

continued

ROOF EDGE PRODUCT DIRECTORY

continued

PART NUMBER	PRODUCT DESCRIPTION	MATERIAL	GAUGE/DECIMAL	QTY. PER	DIAGRAM
32023	2" x 2" Style A Roof Edge (OS No Hem) – Wrap 10'	Steel	32	25	4-1
31990	2" x 2" Style A Roof Edge (OS No Hem) – Wrap 10'	Steel	26	25	4-1
32090	2" x 2" Style A Roof Edge Embossed – Ctns 10'	Steel	32	25	4-1
32025	2" x 2" Style A Roof Edge – Wrap 10'	Aluminum	.017	25	4-1
32025	2" x 2" Style A Roof Edge – Wrap 10'	Steel	29	25	4-1
32026	2" x 2" Style A Roof Edge – Wrap 10'	Steel	32	25	4-1
32024	2" x 2" Style A Roof Edge – Wrap 10'	Steel	34	25	4-1
32027	2" x 3" Style A Roof Edge (2" Face) – Wrap 10'	Steel	29	25	4-1
32569	2" x 4" Style A Roof Edge – Ctns 10'	Aluminum	.017	50	4-1
32047	2" x 4" Style A Roof Edge – Ctns 10'	Steel	26	25	4-1
32014	2" x 4" Style A Roof Edge – Ctns 10'	Steel	29	25	4-1
31988	2" x 4" Style A Roof Edge – Wrap 10'	Aluminum	.017	25	4-1
32019	2" x 4" Style A Roof Edge – Wrap 10'	Steel	32	25	4-1
31994	2" x 4" Style A Roof Edge (120 Degree) – Wrap 10'	Aluminum	.017	25	4-1
32018	2" x 4" Style A Roof Edge (OS No Hem) – Wrap 10'	Steel	32	25	4-1
33103	2" x 4" Style G Roof Edge (OS No Hem) – Wrap 10'	Steel	26	10	4-1
31987	2" x 5" Style A Roof Edge 8/12 Pitch – Wrap 10'	Aluminum	.017	25	4-1
32055	3" x 3" Style A Roof Edge – Wrap 10'	Steel	26	25	4-1
32035	3" x 3" Style A Roof Edge – Wrap 10'	Steel	29	25	4-1
32053	3" x 3" Style A Roof Edge – Wrap 10'	Steel	32	25	4-1
32087	3" x 3" Style A Roof Edge – Wrap 10'	Steel	32	25	4-1
32071	3" x 3" Style A Roof Edge (OS No Hem) – Wrap 10'	Steel	26	25	4-1
32078	3" x 3" Style A Roof Edge (OS No Hem) – Wrap 10'	Steel	32	25	4-1
32061	4" x 4" Style A Roof Edge – Wrap 10'	Steel	26	10	4-1
32041	4" x 4" Style A Roof Edge – Wrap 10'	Steel	29	10	4-1
32059	4" x 4" Style A Roof Edge – Wrap 10'	Steel	32	10	4-1
32043	4" x 4" Style A Roof Edge – Wrap 10'	Steel	34	10	4-1
32077	4" x 4" Style A Roof Edge (OS No Hem) – Ctns 10'	Steel	32	10	4-1
33105	4" Style G FHA Roof Edge (OS No Hem) – Wrap 10'	Steel	26	25	N/A
33109	4" Style G FHA Roof Edge (OS No Hem) – Wrap 10'	Steel	29	25	N/A
32583	4-1/2" Eaves Drip – Ctns 10'	Aluminum	.012	50	5-2
32583	4-1/2" Eaves Drip – Ctns 10'	Aluminum	.017	50	5-2
32571	4-1/2" Eaves Drip – Ctns 10'	Aluminum	.017	50	5-2

continued

ROOF EDGE PRODUCT DIRECTORY

continued

PART NUMBER	PRODUCT DESCRIPTION	MATERIAL	GAUGE/DECIMAL	QTY. PER	DIAGRAM
32570	4-1/2" Eaves Drip – Ctns 10'	Steel	29	25	5-2
32584	4-1/2" Eaves Drip (5" Girth) – Ctns 10'	Aluminum	.012	50	5-2
32578	4-1/2" Style SR Eaves Drip – Ctns 10'	Aluminum	.012	50	6-2
32578	4-1/2" Style SR Eaves Drip – Ctns 10'	Aluminum	.017	50	6-2
32577	4-1/2" Style SR Eaves Drip – Ctns 10'	Steel	29	25	6-2
32579	4-1/2" Style SR Eaves Drip – Ctns 10'	Steel	32	25	6-2
32494	4-1/2" Style SR Roof Edge – Ctns 10'	Aluminum	.017	50	6-1
32493	4-1/2" Style SR Roof Edge – Ctns 10'	Steel	29	25	6-1
32503	4-1/2" Style SR Roof Edge – Ctns 10'	Steel	32	25	6-1
32492	4-1/2" Style SR Roof Edge – Wrap 10'	Steel	32	25	6-1
32542	4-1/2" Style D Roof Edge – Ctns 10'	Aluminum	.017	50	5-1
32516	4-1/2" Style D Roof Edge – Ctns 10'	Steel	29	25	5-1
32515	4-1/2" Style D Roof Edge – Ctns 10'	Steel	32	25	5-1
32523	5" "SR" Eaves Drip – Ctns 10'	Aluminum	.012	50	6-2
32519	5" "SR" Eaves Drip – Ctns 10'	Aluminum	.017	50	6-2
32513	5" "SR" Eaves Drip – Ctns 10'	Steel	29	25	6-2
32586	5" Eaves Drip – Ctns 10'	Aluminum	.012	50	N/A
32585	5" Eaves Drip – Ctns 10'	Aluminum	.017	50	N/A
32508	5" Style SR Roof Edge – Ctns 10'	Aluminum	.017	25	6-1
32511	5" Style SR Roof Edge – Ctns 10'	Aluminum	.017	50	6-1
32498	5" Style SR Roof Edge – Ctns 10'	Steel	26	25	6-1
32512	5" Style SR Roof Edge – Ctns 10'	Steel	26	25	6-1
32508	5" Style SR Roof Edge – Ctns 10'	Steel	29	25	6-1
32509	5" Style SR Roof Edge – Ctns 10'	Steel	32	25	6-1
32200	5" Style C Roof Edge – Ctns 10'	Aluminum	.017	25	4-2
32200	5" Style C Roof Edge – Ctns 10'	Steel	29	25	4-2
32415	5" Style D Roof Edge – Ctns 10'	Steel	29	25	5-1
32416	5" Style D Roof Edge – Ctns 10'	Steel	32	25	5-1
32535	5" Style SROLL Roof Edge – Ctns 10'	Aluminum	.017	50	6-1
32531	5" Style SROLL Roof Edge – Ctns 10'	Steel	32	25	6-1
32520	5" Style SR Eaves Drip – Ctns 10'	Steel	32	25	6-2
32522	5-1/2" SR Eaves Drip – Ctns 10'	Aluminum	.017	50	6-2
32560	5-1/2" Style D Roof Edge – Ctns 10'	Aluminum	.017	50	5-1

continued

ROOF EDGE PRODUCT DIRECTORY

continued

PART NUMBER	PRODUCT DESCRIPTION	MATERIAL	GAUGE/DECIMAL	QTY. PER	DIAGRAM
32550	5-1/2" Style D Roof Edge – Ctns 10'	Steel	29	25	5-1
32673	5-1/2" Style L Roof Edgd – Ctns 10'	Aluminum	.012	50	5-4
32679	5-1/2" Style L Roof Edgd – Ctns 10'	Aluminum	.017	50	5-4
32672	5-1/2" Style L Roof Edgd – Ctns 10'	Aluminum	.017	50	5-4
32674	5-1/2" Style L Roof Edgd – Ctns 10'	Steel	29	25	5-4
32548	5-1/2" Style SROLL Roof Edge – Ctns 10'	Aluminum	.017	50	6-1
32545	5-1/2" Style SROLL Roof Edge – Ctns 10'	Steel	29	25	6-1
32544	5-1/2" Style SROLL Roof Edge – Ctns 10'	Steel	32	25	6-1
32689	5-1/2" Style SROLL Roof Edge – Ctns 10'	Steel	32	25	6-1
32568	6" Style SROLL Roof Edge – 10'	Steel	32	25	6-1
32525	6" SR Eaves Drip – Ctns 10'	Aluminum	.017	50	6-2
32610	6" Modified Roof Edge – Wrap 10'	Steel	32	25	N/A
32910	6" Roof Starter – Wrap 10'	Steel	29	10	8-1
32565	6" Style SR Roof Edge – Ctns 10'	Steel	32	25	N/A
32315	6" Style CC Roof Edge – Wrap 10'	Aluminum	.017	25	4-2
32310	6" Style CC Roof Edge – Wrap 10'	Steel	29	25	4-2
32451	6" Style D Roof Edge – Ctns 10'	Steel	29	25	5-1
32455	6" Style D Roof Edge – Ctns 10'	Steel	29	25	5-1
32452	6" Style D Roof Edge – Ctns 10'	Steel	32	25	5-1
32450	6" Style D Roof Edge – Wrap 10'	Steel	29	25	5-1
32600	6" Style D-GA Gutter Apron – Wrap 10'	Steel	29	25	6-4
32685	6" Style L Roof Edge – Ctns 10'	Aluminum	.017	50	5-4
32683	6" Style L Roof Edge – Ctns 10'	Steel	29	25	5-4
32691	6" Style L Roof Edge – Ctns 10'	Steel	32	25	5-4
32690	6" Style LL Roof Edge – Ctns 10'	Aluminum	.017	25	5-4
32694	6" Style LL Roof Edge – Ctns 10'	Steel	26	25	5-4
32690	6" Style LL Roof Edge – Ctns 10'	Steel	29	25	5-4
32692	6" Style LL Roof Edge – Ctns 10'	Steel	32	25	5-4
32695	6" Style LL Roof Edge – Ctns 12'	Steel	29	20	5-4
32611	7-1/2" Modified Roof Edge – Wrap 10'	Steel	32	25	N/A
32602	8" Eaves Drip – Ctns 10'	Aluminum	.012	50	5-3
32604	8" Eaves Drip – Ctns 10'	Aluminum	.017	50	5-3
32470	8" Style D Roof Edge – Ctns 10'	Steel	29	20	5-1
32530	T-Roof Trim – Ctns 12'	Aluminum	.017	25	7-1

GUTTER APRON PRODUCT DIRECTORY

PART NUMBER	PRODUCT DESCRIPTION	MATERIAL	GAUGE/DECIMAL	QTY. PER	DIAGRAM
32992	2" X 2" Gutter Apron – Ctns 10'	Steel	29	25	N/A
33001	2" X 3" Gutter Apron – Ctns 10'	Aluminum	.012	25	6-3
33007	2" X 3" Gutter Apron – Bdl's 10'	Steel	29	25	6-3
33008	2" X 3" Gutter Apron – Ctns 10'	Aluminum	.017	25	6-3
33008	2" X 3" Gutter Apron – Ctns 10'	Steel	29	25	6-3
33009	2" X 3" Gutter Apron – Ctns 10'	Steel	32	25	6-3
33012	2" X 3" Gutter Apron – Ctns 10'	Steel	26	25	6-3
33015	2" X 4" Gutter Apron – Ctns 10'	Steel	29	25	6-3
33016	2" X 4" Gutter Apron – Ctns 10'	Steel	26	25	6-3
33050	3" X 3" Gutter Apron – Bdl's 10'	Steel	29	25	6-3
32600	6" Style D-Ga Gutter Apron – Wrap 10'	Steel	29	25	6-4

GRAVEL STOP AND MODIFIED ROOF EDGE; DORMER FLASHING; DECK, CHIMNEY (REGLET) AND COUNTER FLASHING; AND RAIN DIVERTER WITH RETURN PRODUCT DIRECTORY

PART NUMBER	PRODUCT DESCRIPTION	MATERIAL	GAUGE/DECIMAL	QTY. PER	DIAGRAM
32700	5" Girth Gravel Stop 10'	Steel	29	25/BDL	7-2
32720	7" Girth Gravel Stop 10'	Steel	29	25/CTN	7-2
32725	8" Girth Gravel Stop 10'	Steel	29	25/BDL	7-2
32732	10" Girth Gravel Stop 10'	Steel	29	10/BDL	7-2
84210	10' Dormer Flashing	Steel	29	10/BDL	9-2
88810	10' Dormer Flashing	Steel	29	10/BDL	9-2
86450	10' Deck Flashing	Steel	29	10/BDL	10-1
88820	10' – 4-1/4" Reglet with Return	Steel	29	10/BDL	10-2
88830	10' – 4-1/4" Reglet with No Return	Steel	29	10/BDL	10-3
85830	10' Deck Starter	Steel	29	10/BDL	10-4
88822	10' – 4-1/4" Counter Flashing	Steel	29	10/BDL	11-1
88824	10' – 4-1/4" Counter Flashing without Lip	Steel	29	10/BDL	11-2
85440	10' – 7-1/2" Rain Diverter	Steel	29	10/BDL	11-3
88950	10' – Rain Diverter with Hem	Steel	29	10/BDL	N/A
89755	10' Rain Diverter	Steel	29	10/BDL	N/A

WINDOW CAPPING PRODUCT DIRECTORY

PART NUMBER	PRODUCT DESCRIPTION	MATERIAL	GAUGE/DECIMAL	QTY. PER	DIAGRAM
33186	1" Header Window Capping – Wrap 10'	Aluminum	.017	50	8-2
33187	1" Header Window Capping 2" Back Leg – Wrap 10'	Aluminum	.017	50	8-2
33187	1" Header Window Capping 2" Back Leg – Wrap 10'	Steel	29	50	8-2
33190	1-1/16" Header Window Capping – Wrap 10'	Aluminum	.017	50	8-2
33190	1-1/16" Header Window Capping – Wrap 10'	Steel	29	50	8-2
33196	1-1/8" Header Window Capping – Wrap 10'	Aluminum	.017	50	8-2
33196	1-1/8" Header Window Capping – Wrap 10'	Steel	29	50	8-2
33197	1-1/8" Header Window Capping – Wrap 10'	Steel	32	50	8-2
33195	1-1/8" Header Window Capping 2" Back Leg – Wrap 10'	Aluminum	.017	50	8-2
33210	1-1/4" Header Window Capping – Wrap 10'	Aluminum	.017	50	8-2
33210	1-1/4" Header Window Capping – Wrap 10'	Steel	29	50	8-2
33211	1-1/4" Header Window Capping 2" Back Leg – Wrap 10'	Aluminum	.017	50	8-2
33200	1-3/8" Header Window Capping – Wrap 10'	Aluminum	.017	50	8-2
33200	1-3/8" Header Window Capping – Wrap 10'	Aluminum	.012	50	8-2
33200	1-3/8" Header Window Capping – Wrap 10'	Steel	29	50	8-2
33201	1-3/8" Header Window Capping 2" Back Leg – Wrap 10'	Aluminum	.017	50	8-2
33220	1-1/2" Header Window Capping – Wrap 10'	Aluminum	.017	50	8-2
33220	1-1/2" Header Window Capping – Wrap 10'	Steel	29	50	8-2
33221	1-1/2" Header Window Capping – Wrap 10'	Steel	32	50	8-2
33230	1-3/4" Header Window Capping – Wrap 10'	Steel	29	50	8-2
33240	2" Header Window Capping – Wrap 10'	Aluminum	.017	50	N/A
33245	2-1/2" Header Window Capping – Wrap 10'	Steel	32	50	N/A

BASE FLASHING PRODUCT DIRECTORY

PART NUMBER	PRODUCT DESCRIPTION	MATERIAL	GAUGE/DECIMAL	QTY. PER	DIAGRAM
33694	5/16" Base Flashing – Tape 8'	Steel	26	25	N/A
33737	5/16" Base Flashing – Tape 8'	Steel	29	25	N/A
33695	5/16" Base Flashing – Wrap 8'	Steel	32	25	N/A
33692	5/16" Base Flashing – Wrap 10'	Steel	32	25	N/A
33693	5/16" Base Flashing – Ctns 10'	Aluminum	.017	50	N/A
33691	5/16" Base Flashing – Wrap 10'	Aluminum	.017	50	N/A
33736	3/8" Base Flashing – Tape 8'	Steel	26	25	9-1
33735	3/8" Base Flashing – Tape 8'	Steel	29	25	9-1
33733	3/8" Base Flashing – Wrap 8'	Steel	32	25	9-1
33739	3/8" Base Flashing – Ctns 10'	Steel	32	25	9-1
33730	3/8" Base Flashing – Wrap 10'	Steel	29	25	9-1
33731	3/8" Base Flashing – Wrap 10'	Steel	29	25	9-1
33734	3/8" Base Flashing – Wrap 10'	Steel	32	25	9-1
33738	3/8" Base Flashing – Ctns 10'	Aluminum	.017	50	9-1
33730	3/8" Base Flashing – Wrap 10'	Aluminum	.017	50	9-1
33206	3/8" Z Flashing – 2" Back – Wrap 10'	Steel	32	25	9-1
33706	7/16" Base Flashing – Tape 8'	Steel	26	25	9-1
33705	7/16" Base Flashing – Tape 8'	Steel	29	25	9-1
33703	7/16" Base Flashing – Wrap 8'	Steel	32	25	9-1
33707	7/16" Base Flashing – Ctns 10'	Steel	32	25	9-1
33700	7/16" Base Flashing – Wrap 10'	Steel	29	25	9-1
33701	7/16" Base Flashing – Wrap 10'	Steel	29	25	9-1
33704	7/16" Base Flashing – Wrap 10'	Steel	32	25	9-1
33700	7/16" Base Flashing – Wrap 10'	Aluminum	.017	50	9-1
33700	7/16" Base Flashing – Wrap 10'	Aluminum	.021	50	9-1
33745	1/2" Base Flashing – Tape 8'	Steel	29	25	9-1
33747	1/2" Base Flashing – Wrap 8'	Steel	32	25	9-1
33743	1/2" Base Flashing – Ctns 10'	Steel	32	25	9-1
33742	1/2" Base Flashing – Tape 10'	Steel	29	25	9-1
33740	1/2" Base Flashing – Wrap 10'	Steel	29	25	9-1
33741	1/2" Base Flashing – Wrap 10'	Steel	29	25	9-1
33744	1/2" Base Flashing – Wrap 10'	Steel	32	25	9-1

continued

BASE FLASHING PRODUCT DIRECTORY

continued

PART NUMBER	PRODUCT DESCRIPTION	MATERIAL	GAUGE/DECIMAL	QTY. PER	DIAGRAM
33740	1/2" Base Flashing – Wrap 10'	Aluminum	.012	50	9-1
33715	5/8" Base Flashing – Tape 8'	Steel	26	25	9-1
33718	5/8" Base Flashing – Tape 8'	Steel	29	25	9-1
33710	5/8" Base Flashing – Wrap 10'	Steel	29	25	9-1
33711	5/8" Base Flashing – Wrap 10'	Steel	29	25	9-1
33717	5/8" Base Flashing – Wrap 10'	Steel	32	25	9-1
33712	5/8" Base Flashing – Wrap 10'	Steel	32	25	9-1
33712	5/8" Base Flashing – Wrap 10'	Steel	29	25	9-1
33714	5/8" Base Flashing – Ctns 10'	Aluminum	.017	50	9-1
33711	5/8" Base Flashing – Wrap 10'	Aluminum	.012	50	9-1
33710	5/8" Base Flashing – Wrap 10'	Aluminum	.017	50	9-1
33711	5/8" Base Flashing – Wrap 10'	Aluminum	.017	50	9-1
33710	5/8" Base Flashing – Wrap 10'	Aluminum	.021	50	9-1
33826	3/4" Base Flashing (105 Degree) – Ctns 10'	Aluminum	.017	50	9-1
33727	3/4" Base Flashing – Tape 8'	Steel	26	25	9-1
33725	3/4" Base Flashing – Tape 8'	Steel	29	25	9-1
33723	3/4" Base Flashing – Wrap 8'	Steel	32	25	9-1
33708	3/4" Base Flashing – Ctns 10'	Steel	32	25	9-1
33720	3/4" Base Flashing – Wrap 10'	Steel	29	25	9-1
33721	3/4" Base Flashing – Wrap 10'	Steel	29	25	9-1
33724	3/4" Base Flashing – Wrap 10'	Steel	32	25	9-1
33728	3/4" Base Flashing – Ctns 10'	Aluminum	.017	50	9-1
33720	3/4" Base Flashing – Wrap 10'	Aluminum	.012	50	9-1
33720	3/4" Base Flashing – Wrap 10'	Aluminum	.017	50	9-1
33721	3/4" Base Flashing – Wrap 10'	Aluminum	.017	50	9-1
33762	7/8" Base Flashing – Tape 8'	Steel	26	25	N/A
33854	7/8" Base Flashing – Tape 8'	Steel	29	25	N/A
33855	7/8" Base Flashing – Wrap 8'	Steel	32	25	N/A
33758	7/8" Base Flashing – Wrap 10'	Steel	32	25	N/A
33822	7/8" Base Flashing – Ctns 10'	Aluminum	.017	50	N/A
33751	7/8" Base Flashing – Wrap 10'	Aluminum	.017	50	N/A
33815	1" Base Flashing – Tape 8'	Steel	26	25	9-1

continued

BASE FLASHING PRODUCT DIRECTORY

continued

PART NUMBER	PRODUCT DESCRIPTION	MATERIAL	GAUGE/DECIMAL	QTY. PER	DIAGRAM
33763	1" Base Flashing – Tape 8'	Steel	29	25	9-1
33767	1" Base Flashing – Wrap 8'	Steel	32	25	9-1
33830	1" Base Flashing – Ctns 10'	Steel	32	25	9-1
33760	1" Base Flashing – Wrap 10'	Steel	29	25	9-1
33764	1" Base Flashing – Wrap 10'	Steel	32	25	9-1
33778	1" Base Flashing – Ctns 10'	Aluminum	.017	50	9-1
33760	1" Base Flashing – Wrap 10'	Aluminum	.012	50	9-1
33760	1" Base Flashing – Wrap 10'	Aluminum	.017	50	9-1
33208	1" Z Flashing – 2" Back – Ctns 10'	Steel	32	25	9-1
33209	1" Z Flashing – 2" Back – Ctns 10'	Aluminum	.012	50	9-1
33835	1-1/8" Base Flashing – Ctns 10'	Steel	32	25	9-1
33765	1-1/8" Base Flashing – Wrap 10'	Steel	29	25	9-1
33755	1-1/8" Base Flashing – Wrap 10'	Steel	32	25	9-1
33768	1-1/8" Base Flashing – Ctns 10'	Aluminum	.017	50	9-1
33765	1-1/8" Base Flashing – Wrap 10'	Aluminum	.017	50	9-1
33825	1-1/4" Base Flashing (105 Degree) – Ctns 10'	Aluminum	.017	50	N/A
33816	1-1/4" Base Flashing – Tape 8'	Steel	26	25	N/A
33774	1-1/4" Base Flashing – Tape 8'	Steel	29	25	N/A
33773	1-1/4" Base Flashing – Wrap 8'	Steel	32	25	N/A
33831	1-1/4" Base Flashing – Ctns 10'	Steel	32	25	N/A
33770	1-1/4" Base Flashing – Wrap 10'	Steel	29	25	N/A
33772	1-1/4" Base Flashing – Wrap 10'	Steel	29	25	N/A
33769	1-1/4" Base Flashing – Wrap 10'	Steel	32	25	N/A
33818	1-1/4" Base Flashing – Ctns 10'	Aluminum	.017	50	N/A
33770	1-1/4" Base Flashing – Wrap 10'	Aluminum	.017	50	N/A
33771	1-1/4" Base Flashing – Wrap 10'	Aluminum	.017	50	N/A
33839	1-3/8" Base Flashing – Ctns 10'	Steel	32	25	N/A
33777	1-3/8" Base Flashing – Tape 10'	Steel	29	25	N/A
33824	1-1/2" Base Flashing (105 Degree) – Ctns 10'	Aluminum	.017	50	N/A
33817	1-1/2" Base Flashing – Tape 8'	Steel	26	25	N/A
33784	1-1/2" Base Flashing – Tape 8'	Steel	29	25	N/A
33821	1-1/2" Base Flashing – Wrap 8'	Steel	32	25	N/A

continued

BASE FLASHING PRODUCT DIRECTORY

continued

PART NUMBER	PRODUCT DESCRIPTION	MATERIAL	GAUGE/DECIMAL	QTY. PER	DIAGRAM
33832	1-1/2" Base Flashing – Ctns 10'	Steel	32	25	N/A
33782	1-1/2" Base Flashing – Tape 10'	Steel	29	25	N/A
33780	1-1/2" Base Flashing – Wrap 10'	Steel	29	25	N/A
33779	1-1/2" Base Flashing – Wrap 10'	Steel	32	25	N/A
33783	1-1/2" Base Flashing – Ctns 10'	Aluminum	.017	50	N/A
33780	1-1/2" Base Flashing – Wrap 10'	Aluminum	.017	50	N/A
33781	1-1/2" Base Flashing – Wrap 10'	Aluminum	.017	50	N/A
33759	1-5/8" Base Flashing – Wrap 10'	Steel	32	25	N/A
33836	1-3/4" Base Flashing – Ctns 10'	Steel	32	25	9-1
33841	1-3/4" Base Flashing (105 Degree) – Ctns 10'	Aluminum	.017	50	9-1
33788	1-3/4" Base Flashing – Tape 8'	Steel	29	25	9-1
33793	1-3/4" Base Flashing – Tape 8'	Steel	26	25	9-1
33790	1-3/4" Base Flashing – Wrap 10'	Steel	29	25	9-1
33823	1-3/4" Base Flashing – Ctns 10'	Aluminum	.017	50	9-1
33791	1-3/4" Base Flashing – Wrap 10'	Aluminum	.017	50	9-1
33833	2" Base Flashing – Ctns 10'	Steel	32	25	N/A
33799	2" Base Flashing – Tape 8'	Steel	26	25	N/A
33789	2" Base Flashing – Tape 8'	Steel	29	25	N/A
33794	2" Base Flashing – Wrap 8'	Steel	32	25	N/A
33797	2" Base Flashing – Wrap 10'	Steel	29	25	N/A
33857	2" Base Flashing – Wrap 10'	Steel	32	25	N/A
33797	2" Base Flashing – Wrap 10'	Steel	32	25	N/A
33819	2" Base Flashing – Ctns 10'	Aluminum	.017	50	N/A
33806	2-1/4" Base Flashing – Tape 8'	Steel	29	25	N/A
33828	2-1/4" Base Flashing – Ctns 10'	Aluminum	.017	50	N/A
33834	2-1/2" Base Flashing – Ctns 10'	Steel	32	25	N/A
33840	2-1/2" Base Flashing – Wrap 10'	Steel	32	25	N/A
33809	2-1/2" Base Flashing – Tape 8'	Steel	26	25	N/A
33812	2-1/2" Base Flashing – Tape 8'	Steel	32	25	N/A
33858	3" Base Flashing – Tape 8'	Steel	26	25	N/A

ANGLE FLASHING PRODUCT DIRECTORY

PART NUMBER	PRODUCT DESCRIPTION	MATERIAL	GAUGE/DECIMAL	QTY. PER	DIAGRAM
33310	1" x 3" Angle Flashing with Hems – Wrap 10'	Steel	29	10	12-2
33330	1-1/2" x 2-1/2" Angle Flashing with Hems – Wrap 10'	Steel	29	10	12-2
89690	1-1/2" x 4-1/2" Angle Flashing (100 Degrees) – Wrap 10'	Steel	32	10	12-1
42255	1-1/2" x 1-1/2" Angle Flashing – Wrap 12'	Steel	29	10	12-1
42250	1-1/2" x 1-1/2" Angle Flashing with Hems – Wrap 10'	Steel	29	10	12-2
42251	1-1/2" x 1-1/2" Angle Flashing with Hems – Wrap 10'	Steel	32	10	12-2
33371	2" x 2" Angle Flashing – Wrap 10'	Steel	32	10	12-1
33373	2" x 2" Angle Flashing – Wrap 10'	Steel	29	25	12-1
42220	2" x 2" Angle Flashing – Wrap 10'	Steel	29	10	12-1
33367	2" x 2" Angle Flashing (100 Degrees) – Wrap 10'	Aluminum	28	100	12-1
42270	2" x 2" Angle Flashing with Hems – Wrap 10'	Steel	29	10	12-2
42225	2" x 2" Inside Angle Flashing with Hems – Wrap 10'	Steel	29	25	14-1
33377	2" x 3" Angle Flashing with Hems – Wrap 10'	Steel	32	10	12-2
33400	2-1/2" x 2-1/2" Angle Flashing – Wrap 10'	Steel	29	10	12-1
88772	2-1/2" x 2-1/2" Angle Flashing with Hems – Wrap 12' 1"	Steel	29	10	12-2
33404	3" x 3" Angle Flashing – Wrap 10'	Steel	26	25	12-1
33411	3" x 3" Angle Flashing – Wrap 10'	Steel	32	10	12-1
42240	3" x 3" Angle Flashing – Wrap 10'	Aluminum	32	10	12-1
42240	3" x 3" Angle Flashing – Wrap 10'	Steel	29	10	12-1
42243	3" x 3" Angle Flashing – Wrap 10'	Steel	29	25	12-1
89750	3" x 3" Angle Flashing (110 Degrees) with One 1/2" Flat Hem – Wrap 10'	Steel	29	10	12-1
44291	3" x 3" Angle Flashing (120 Degrees) with Hems – Wrap 10'	Steel	32	10	12-2
42290	3" x 3" Angle Flashing with Hems – Wrap 10'	Steel	29	10	12-2
42295	3" x 3" Angle Flashing with Hems – Wrap 12'	Steel	29	10	12-2
42302	3" x 3" Inside Angle Flashing – Wrap 12'	Steel	29	10	13-2
33420	3" x 4" Angle Flashing – Wrap 10'	Steel	32	10	12-1
33426	3" x 4" Angle Flashing – Wrap 12'	Steel	32	12	12-1
33425	3" x 5" Angle Flashing – Wrap 10'	Steel	32	10	12-1
33424	3" x 5" Angle Flashing with Hems – Wrap 10'	Steel	29	10	12-2
33444	3" x 5" Angle Flashing with Hems – Wrap 10'	Steel	32	10	12-2
87341	4" x 3-1/2" Angle Flashing – Wrap 10'	Steel	32	10	12-1
87340	4" x 3-1/2" Angle Flashing with Lip – Wrap 10'	Steel	26	10	13-1
33479	4" x 4" Angle Flashing (120 Degrees) – Wrap 10'	Steel	29	10	12-1

continued

ANGLE FLASHING PRODUCT DIRECTORY

continued

PART NUMBER	PRODUCT DESCRIPTION	MATERIAL	GAUGE/DECIMAL	QTY. PER	DIAGRAM
33439	4" x 4" Angle Flashing – Ctn 10'	Steel	26	10	12-1
33430	4" x 4" Angle Flashing – Wrap 10'	Steel	29	10	12-1
33433	4" x 4" Angle Flashing – Wrap 10'	Steel	32	10	12-1
33440	4" x 4" Angle Flashing – Wrap 10'	Steel	26	10	12-1
33441	4" x 4" Angle Flashing – Wrap 10'	Steel	29	10	12-1
33437	4" x 4" Angle Flashing (120 Degrees) – Wrap 10'	Steel	32	10	12-1
33460	4" x 4" Angle Flashing with Hems – Wrap 10'	Steel	29	10	12-2
85724	4" x 4" Angle Flashing with Lip – Bulk Pk 10'	Steel	32	500	13-1
85720	4" x 4" Angle Flashing with Lip – Wrap 10'	Aluminum	32	10	13-1
85720	4" x 4" Angle Flashing with Lip – Wrap 10'	Steel	32	10	13-1
88011	4" x 4" Angle Flashing with Reverse Lip – Wrap 10'	Steel	32	10	13-1
33475	4" x 4" Inside Angle Flashing – Wrap 10'	Steel	29	10	13-2
33477	4" x 4" Inside Angle Flashing – Wrap 10'	Steel	32	10	13-2
33471	4" x 4" Inside Angle Flashing (112 Degrees) – Wrap 10'	Steel	29	10	13-2
33478	4" x 4" Inside Angle Flashing (120 Degrees) – Wrap 10'	Steel	29	10	13-2
33476	4" x 4" Inside Angle Flashing with Hems – Wrap 10'	Steel	29	10	14-1
88015	4" x 4" Inside Angle Flashing with Reverse Lip – Wrap 10'	Steel	32	10	13-3
85718	4" x 4" Inside Angle Flashing with Lip – Wrap 10'	Steel	29	10	13-4
33493	4" x 5" Angle Flashing – Ctn 10'	Steel	26	10	12-1
33490	4" x 5" Angle Flashing – Wrap 10'	Steel	32	10	12-1
33494	4" x 5" Angle Flashing – Wrap 10'	Steel	29	10	12-1
33491	4" x 5" Angle Flashing (120 Degrees) – Wrap 10'	Steel	29	10	12-1
33492	4" x 5" Angle Flashing (120 Degrees) – Wrap 10'	Steel	32	10	12-1
86000	4" x 5" Angle Flashing with Lip – Wrap 10'	Steel	32	10	13-1
33540	4" x 6" Angle Flashing – Wrap 10'	Steel	29	10	12-1
33541	4" x 6" Inside Angle Flashing – Wrap 10'	Steel	29	10	13-2
33545	4" x 6" Inside Angle Flashing – Wrap 10'	Steel	32	10	13-2
33546	4" x 6" Inside Angle Flashing (120 Degrees) – Wrap 10'	Steel	32	10	13-2
33552	4" x 6" Inside Angle Flashing (120 Degrees) – Wrap 10'	Steel	26	10	13-2
33550	4" x 6" Inside Angle Flashing with Hems – Wrap 10'	Steel	29	10	14-1
33553	4" x 6" Inside Angle Flashing with Hems – Wrap 10'	Steel	32	10	14-1
33500	5" x 5" Angle Flashing – Wrap 10'	Steel	29	10	12-1
33501	5" x 5" Angle Flashing – Wrap 10'	Steel	32	10	12-1

continued

ANGLE FLASHING PRODUCT DIRECTORY

continued

PART NUMBER	PRODUCT DESCRIPTION	MATERIAL	GAUGE/DECIMAL	QTY. PER	DIAGRAM
33511	5" x 5" Angle Flashing – Wrap 10'	Steel	26	10	12-1
33504	5" x 5" Angle Flashing (120 Degrees) – Wrap 10'	Steel	32	10	12-1
33509	5" x 5" Angle Flashing with Hems – Wrap 10'	Steel	32	10	12-2
33603	6" x 6" Angle Flashing – Ctn 10'	Steel	32	10	12-1
33600	6" x 6" Angle Flashing – Wrap 10'	Steel	29	10	12-1
33601	6" x 6" Angle Flashing – Wrap 10'	Steel	32	10	12-1
33612	6" x 6" Angle Flashing – Wrap 10'	Steel	26	10	12-1
33610	6" x 6" Angle Flashing with Hems – Wrap 10'	Steel	29	10	12-2
85970	6" x 6" Angle Flashing with Lip – Ctn 10'	Steel	32	10	13-1
85973	6" x 6" Angle Flashing with Lip – Ctn 10'	Steel	29	10	13-1
85971	6" x 6" Angle Flashing with Lip – Wrap 10'	Steel	29	20	13-1
33608	6" x 6" Inside Angle Flashing with Hems – Wrap 10'	Steel	29	10	14-1

ROLL VALLEY PRODUCT DIRECTORY

PART NUMBER	PRODUCT DESCRIPTION	MATERIAL	GAUGE/DECIMAL	NOTE
29403	4" .010 Roll Valley – 10' Rolls	Steel	34	
29405	4" .010 Roll Valley – 25' Rolls	Steel	34	
29400	4" .010 Roll Valley – 50' Rolls	Steel	34	
29143	4" Economy Aluminum Roll Valley – 10' Rolls	Aluminum	.009	
29145	4" Economy Aluminum Roll Valley – 25' Rolls	Aluminum	.009	
29140	4" Economy Aluminum Roll Valley – 50' Rolls	Aluminum	.009	
30140	4" Ptd Alum Trim Coil – 50' Rolls	Aluminum	.017	
30003	4" Roll Valley – 10' Rolls	Steel	32	
30005	4" Roll Valley – 25' Rolls	Steel	32	
30000	4" Roll Valley – 50' Rolls	Steel	29	
30000	4" Roll Valley – 50' Rolls	Steel	32	
30143	4" Std Aluminum Roll Valley – 10' Rolls	Aluminum	.012	
30145	4" Std Aluminum Roll Valley – 25' Rolls	Aluminum	.012	
30140	4" Std Aluminum Roll Valley – 50' Rolls	Aluminum	.012	

continued

ROLL VALLEY PRODUCT DIRECTORY

continued

PART NUMBER	PRODUCT DESCRIPTION	MATERIAL	GAUGE/DECIMAL	NOTE
29413	6" .010 Roll Valley – 10' Rolls	Steel	34	
29415	6" .010 Roll Valley – 25' Rolls	Steel	34	
29410	6" .010 Roll Valley – 50' Rolls	Steel	34	
29153	6" Economy Aluminum Roll Valley – 10' Rolls	Aluminum	.009	
29155	6" Economy Aluminum Roll Valley – 25' Rolls	Aluminum	.009	
29150	6" Economy Aluminum Roll Valley – 50' Rolls	Aluminum	.009	
30150	6" Ptd Alum Trim Coil – 50' Rolls	Aluminum	.017	
30013	6" Roll Valley – 10' Rolls	Steel	32	
30015	6" Roll Valley – 25' Rolls	Steel	32	
30010	6" Roll Valley – 50' Rolls	Steel	29	
30010	6" Roll Valley – 50' Rolls	Steel	32	
30017	6" Roll Valley (.012) – 25' Rolls	Steel	32	Painted Only
30153	6" Std Aluminum Roll Valley – 10' Rolls	Aluminum	.012	
30155	6" Std Aluminum Roll Valley – 25' Rolls	Aluminum	.012	
30150	6" Std Aluminum Roll Valley – 50' Rolls	Aluminum	.012	
29423	8" .010 Roll Valley – 10' Rolls	Steel	34	
29425	8" .010 Roll Valley – 25' Rolls	Steel	34	
29420	8" .010 Roll Valley – 50' Rolls	Steel	34	
29163	8" Economy Aluminum Roll Valley – 10' Rolls	Aluminum	.009	
29165	8" Economy Aluminum Roll Valley – 25' Rolls	Aluminum	.009	
29160	8" Economy Aluminum Roll Valley – 50' Rolls	Aluminum	.009	
30023	8" Roll Valley – 10' Rolls	Steel	32	
30025	8" Roll Valley – 25' Rolls	Steel	32	
30020	8" Roll Valley – 50' Rolls	Steel	29	
30020	8" Roll Valley – 50' Rolls	Steel	32	
30027	8" Roll Valley (.012) – 25' Rolls	Steel	32	Painted Only
30163	8" Std Aluminum Roll Valley 10' Rolls	Aluminum	.012	
30165	8" Std Aluminum Roll Valley 25' Rolls	Aluminum	.012	
30160	8" Std Aluminum Roll Valley 50' Rolls	Aluminum	.012	
29433	10" .010 Roll Valley – 10' Rolls	Steel	34	
29435	10" .010 Roll Valley – 25' Rolls	Steel	34	
29430	10" .010 Roll Valley – 50' Rolls	Steel	34	

ROLL VALLEY PRODUCT DIRECTORY

continued

PART NUMBER	PRODUCT DESCRIPTION	MATERIAL	GAUGE/DECIMAL	NOTE
29173	10" Economy Aluminum Roll Valley – 10' Rolls	Aluminum	.009	
29175	10" Economy Aluminum Roll Valley – 25' Rolls	Aluminum	.009	
29170	10" Economy Aluminum Roll Valley – 50' Rolls	Aluminum	.009	
30173	10" Ptd Alum Trim Coil – 10' Rolls	Aluminum	.017	
30170	10" Ptd Alum Trim Coil – 50' Rolls	Aluminum	.017	
30033	10" Roll Valley – 10' Rolls	Steel	32	
30035	10" Roll Valley – 25' Rolls	Steel	32	
30030	10" Roll Valley – 50' Rolls	Steel	32	
30030	10" Roll Valley – 50' Rolls	Steel	29	
30037	10" Roll Valley (.012) – 25' Rolls	Steel	32	Painted Only
30034	10" Roll Valley (.012) – 50' Rolls	Steel	32	Painted Only
30173	10" Std Aluminum Roll Valley – 10' Rolls	Aluminum	.012	
30175	10" Std Aluminum Roll Valley – 25' Rolls	Aluminum	.012	
30170	10" Std Aluminum Roll Valley – 50' Rolls	Aluminum	.012	
29443	12" .010 Roll Valley – 10' Rolls	Steel	34	
29445	12" .010 Roll Valley – 25' Rolls	Steel	34	
29440	12" .010 Roll Valley – 50' Rolls	Steel	34	
29183	12" Economy Aluminum Roll Valley – 10' Rolls	Aluminum	.009	
29185	12" Economy Aluminum Roll Valley – 25' Rolls	Aluminum	.009	
29180	12" Economy Aluminum Roll Valley – 50' Rolls	Aluminum	.009	
30180	12" Ptd Alum Trim Coil – 50' Rolls	Aluminum	.017	
30043	12" Roll Valley – 10' Rolls	Steel	32	
30045	12" Roll Valley – 25' Rolls	Steel	32	
30040	12" Roll Valley – 50' Rolls	Steel	29	
30040	12" Roll Valley – 50' Rolls	Steel	32	
30041	12" Roll Valley – 50' Rolls => 26 Ga. <=	Steel	26	
30047	12" Roll Valley (.012) – 25' Rolls	Steel	32	Painted Only
30183	12" Std Aluminum Roll Valley – 10' Rolls	Aluminum	.012	
30185	12" Std Aluminum Roll Valley – 25' Rolls	Aluminum	.012	
30180	12" Std Aluminum Roll Valley – 50' Rolls	Aluminum	.012	
29453	14" .010 Roll Valley – 10' Rolls	Steel	34	
29455	14" .010 Roll Valley – 25' Rolls	Steel	34	
29450	14" .010 Roll Valley – 50' Rolls	Steel	34	

continued

ROLL VALLEY PRODUCT DIRECTORY

continued

PART NUMBER	PRODUCT DESCRIPTION	MATERIAL	GAUGE/DECIMAL	NOTE
29193	14" Economy Aluminum Roll Valley – 10' Rolls	Aluminum	.009	
29195	14" Economy Aluminum Roll Valley – 25' Rolls	Aluminum	.009	
29190	14" Economy Aluminum Roll Valley – 50' Rolls	Aluminum	.009	
30193	14" Ptd Alum Trim Coil – 10' Rolls	Aluminum	.017	
30195	14" Ptd Alum Trim Coil – 25' Rolls	Aluminum	.017	
30190	14" Ptd Alum Trim Coil – 50' Rolls	Aluminum	.017	
30053	14" Roll Valley – 10' Rolls	Steel	32	
30055	14" Roll Valley – 25' Rolls	Steel	32	
30050	14" Roll Valley – 50' Rolls	Steel	29	
30050	14" Roll Valley – 50' Rolls	Steel	32	
30057	14" Roll Valley (.012) – 25' Rolls	Steel	32	Painted Only
30193	14" Std Aluminum Roll Valley – 10' Rolls	Aluminum	.012	
30195	14" Std Aluminum Roll Valley – 25' Rolls	Aluminum	.012	
30190	14" Std Aluminum Roll Valley – 50' Rolls	Aluminum	.012	
29463	16" .010 Roll Valley – 10' Rolls	Steel	34	
29465	16" .010 Roll Valley – 25' Rolls	Steel	34	
29460	16" .010 Roll Valley – 50' Rolls	Steel	34	
29203	16" Economy Aluminum Roll Valley – 10' Rolls	Aluminum	.009	
29205	16" Economy Aluminum Roll Valley – 25' Rolls	Aluminum	.009	
29200	16" Economy Aluminum Roll Valley – 50' Rolls	Aluminum	.009	
30200	16" Ptd Alum Trim Coil – 50' Rolls	Aluminum	.017	
30063	16" Roll Valley – 10' Rolls	Steel	32	
30065	16" Roll Valley – 25' Rolls	Steel	32	
30060	16" Roll Valley – 50' Rolls	Steel	29	
30060	16" Roll Valley – 50' Rolls	Steel	32	
30203	16" Std Aluminum Roll Valley – 10' Rolls	Aluminum	.012	
30205	16" Std Aluminum Roll Valley – 25' Rolls	Aluminum	.012	
30200	16" Std Aluminum Roll Valley – 50' Rolls	Aluminum	.012	
29473	18" .010 Roll Valley – 10' Rolls	Steel	34	
29475	18" .010 Roll Valley – 25' Rolls	Steel	34	
29470	18" .010 Roll Valley – 50' Rolls	Steel	34	
29210	18" Economy Aluminum Roll Valley – 50' Rolls	Aluminum	.009	
30210	18" Ptd Alum Trim Coil – 50' Rolls	Aluminum	.017	

continued

ROLL VALLEY PRODUCT DIRECTORY

continued

PART NUMBER	PRODUCT DESCRIPTION	MATERIAL	GAUGE/DECIMAL	NOTE
30073	18" Roll Valley – 10' Rolls	Steel	32	
30075	18" Roll Valley – 25' Rolls	Steel	32	
30070	18" Roll Valley – 50' Rolls	Steel	32	
30217	19" Ptd Alum Trim Coil – 50' Rolls	Aluminum	.017	Soffit Coil
29483	20" .010 Roll Valley – 10' Rolls	Steel	34	
29485	20" .010 Roll Valley – 25' Rolls	Steel	34	
29480	20" .010 Roll Valley – 50' Rolls	Steel	34	
29223	20" Economy Aluminum Roll Valley – 10' Rolls	Aluminum	.009	
29225	20" Economy Aluminum Roll Valley – 25' Rolls	Aluminum	.009	
29220	20" Economy Aluminum Roll Valley – 50' Rolls	Aluminum	.009	
30220	20" Ptd Alum Trim Coil – 50' Rolls	Aluminum	.017	
30083	20" Roll Valley – 10' Rolls	Steel	32	
30085	20" Roll Valley – 25' Rolls	Steel	32	
30080	20" Roll Valley – 50' Rolls	Steel	29	
30080	20" Roll Valley – 50' Rolls	Steel	32	
30081	20" Roll Valley – 50' Rolls (8" I.D.) => 26 Ga. <=	Steel	26	Small Diameter
30087	20" Roll Valley (.012) – 25' Rolls	Steel	32	Painted Only
30084	20" Roll Valley (.012) – 50' Rolls	Steel	32	Painted Only
30223	20" Std Aluminum Roll Valley – 10' Rolls	Aluminum	.012	
30225	20" Std Aluminum Roll Valley – 25' Rolls	Aluminum	.012	
30220	20" Std Aluminum Roll Valley – 50' Rolls	Aluminum	.012	
29493	24" .010 Roll Valley – 10' Rolls	Steel	34	
29495	24" .010 Roll Valley – 25' Rolls	Steel	34	
29490	24" .010 Roll Valley – 50' Rolls	Steel	34	
29233	24" Economy Aluminum Roll Valley – 10' Rolls	Aluminum	.009	
29235	24" Economy Aluminum Roll Valley – 25' Rolls	Aluminum	.009	
29230	24" Economy Aluminum Roll Valley – 50' Rolls	Aluminum	.009	
30230	24" Ptd Alum Trim Coil – 50' Rolls	Aluminum	.021	
30230	24" Ptd Alum Trim Coil – 50' Rolls	Aluminum	.021	
30230	24" Ptd Alum Trim Coil – 50' Rolls	Aluminum	.017	
30232	24" Ptd Alum Trim Coil – 50' Rolls – (10" Id)	Aluminum	.017	Large Diameter
30230	24" Ptd Alum Trim Coil – 50' Rolls	Aluminum	.017	
30093	24" Roll Valley – 10' Rolls	Steel	32	

continued

ROLL VALLEY PRODUCT DIRECTORY

continued

PART NUMBER	PRODUCT DESCRIPTION	MATERIAL	GAUGE/DECIMAL	NOTE
30095	24" Roll Valley – 25' Rolls	Steel	32	
30096	24" Roll Valley – 25' Rolls => 26 Ga. <=	Steel	26	
30090	24" Roll Valley – 50' Rolls	Steel	29	
30090	24" Roll Valley – 50' Rolls	Steel	32	
30091	24" Roll Valley – 50' Rolls => 26 Ga. <=	Steel	26	
30233	24" Std Aluminum Roll Valley – 10' Rolls	Aluminum	.012	
30230	24" Std Aluminum Roll Valley – 50' Rolls	Aluminum	.012	
30231	24" Wood Grain Ptd Alum Trim Coil – 50' Rolls	Aluminum	.021	
30231	24" Wood Grain Ptd Alum Trim Coil – 50' Rolls	Aluminum	.017	
30110	28" Roll Valley – 50' Rolls	Steel	32	
29510	30" .010 Roll Valley – 50' Rolls	Steel	34	
30120	30" Roll Valley – 50' Rolls	Steel	32	
29520	36" .010 Roll Valley – 50' Rolls	Steel	34	
29260	36" Economy Aluminum Roll Valley – 50' Rolls	Aluminum	.009	
30133	36" Roll Valley – 10' Rolls	Steel	32	
30135	36" Roll Valley – 25' Rolls	Steel	32	
30130	36" Roll Valley – 50' Rolls	Steel	32	
30260	36" Std Aluminum Roll Valley – 50' Rolls	Aluminum	.012	

W VALLEY PRODUCT DIRECTORY

PART NUMBER	PRODUCT DESCRIPTION	MATERIAL	GAUGE/DECIMAL	QTY. PER	DIAGRAM
30537	18" Style W Formed Valley 10' with Hemmed Edges	Steel	29	10/BDL	N/A
30550	20" Style W Formed Valley 10'	Steel	29	10/BDL	14-2
30551	20" Style W Formed Valley 10'	Steel	29	10/BDL	14-2
30554	20" Style W Formed Valley 10' with Hemmed Edges	Steel	29	10/BDL	14-2
30590	24" Style W Formed Valley 10'	Steel	29	10/BDL	14-2
30591	24" Style W Formed Valley 10'	Steel	26	10/BDL	14-2
30597	24" Style W Formed Valley 10' with Hemmed Edges	Steel	26	10/BDL	14-2
30594	24" Style W Formed Valley 10' with Hemmed Edges	Steel	29	10/BDL	14-2
30536	18" Style W Formed Valley 10' with Crimped Edge	Steel	29	10/BDL	14-3
30594	24" Style W Formed Valley 10' with 1/2" Hemmed Edges	Aluminum	28	10/BDL	N/A

SHINGLES PRODUCT DIRECTORY

PART NUMBER	PRODUCT DESCRIPTION	MATERIAL	GAUGE/DECIMAL	QTY. PER
31410	5" x 7" Shingles	Aluminum	.012	100/BDL
31410	5" x 7" Shingles	Steel	32	100/BDL
31416	5" x 7" Shingles	Aluminum	.012	100/BDL 500/CTN
31405	5" x 7" Shingles	Steel	32	100/CTN
31406	5" x 7" Shingles	Steel	34	100/CTN
31419	5" x 7" Shingles with Crimp (2" x 3" x 7")	Steel	34	100/CTN
31418	5" x 7" Shingles with Crimp (2" x 3" x 7")	Aluminum	.012	100/BDL 500/CTN
31414	5" x 7" Shingles with Crimp (2-1/2" x 2-1/2" x 7")	Steel	34	100/CTN
31413	5" x 7" Shingles with Crimp (2" x 3" x 7")	Aluminum	32	100/CTN
31413	5" x 7" Shingles with Crimp (2" x 3" x 7")	Steel	32	100/CTN
31412	5" x 7" Shingles with Crimp (2-1/2" x 2-1/2" x 7")	Steel	32	100/CTN
31412	5" x 7" Shingles with Crimp (2-1/2" x 2-1/2" x 7")	Aluminum	.012	100/CTN
31417	5" x 7" Shingles with Crimp (2-1/2" x 2-1/2" x 7")	Aluminum	.012	100/BDL 500/CTN
31430	6" x 12" Shingles	Aluminum	.012	100/BDL
31430	6" x 12" Shingles	Aluminum	.017	100/BDL
31440	6" x 8" Shingles	Steel	32	100/BDL
31436	6" x 8" Shingles with Crimp (2" x 4" x 8")	Steel	32	100/CTN
31442	6" x 8" Shingles with Crimp (3" x 3" x 8")	Steel	32	100/BDL
31439	6" x 8" Shingles with Crimp (3" x 3" x 8")	Aluminum	.012	100/BDL 500/CTN
31437	6" x 8" Shingles with Crimp (2" x 4" x 8")	Steel	34	100/CTN
31448	7" x 7" Shingles with Crimp (3" x 4" x 7")	Steel	34	100/CTN
31459	7" x 7" Shingles with Crimp (3" x 4" x 7")	Steel	32	100/CTN
31458	7" x 7" Shingles with Crimp (3" x 4" x 7")	Aluminum	.012	100/BDL 500/CTN
31459	7" x 7" Shingles with Crimp (3" x 4" x 7")	Aluminum	.012	100/CTN
31451	7" x 9" Shingles with Crimp (3" x 4" x 9")	Aluminum	.012	100/BDL 500/CTN
31546	8" x 10" Shingles with Crimp (4" x 4" x 10")	Aluminum	.012	50 PER BDL
31498	8" x 12" Shingles with Crimp (4" x 4" x 12")	Aluminum	.012	100/CTN
31498	8" x 12" Shingles with Crimp (4" x 4" x 12")	Steel	32	100/CTN
31548	8" x 12" Shingles with Crimp (4" x 4" x 12")	Steel	29	50/BDL
31548	8" x 12" Shingles with Crimp (4" x 4" x 12")	Steel	32	50/BDL
31520	8" x 14" Shingles	Steel	32	50/BDL
31522	8" x 14" Shingles with Crimp (4" x 4" x 14")	Steel	32	50/BDL

continued

SHINGLES PRODUCT DIRECTORY

continued

PART NUMBER	PRODUCT DESCRIPTION	MATERIAL	GAUGE/DECIMAL	QTY. PER
31462	8" x 7" Shingles with Crimp (4" x 4" x 7")	Aluminum	.012	100/CTN
31467	8" x 7" Shingles with Crimp (4" x 4" x 7")	Steel	34	100/CTN
31478	8" x 8" Shingles	Steel	34	100/BDL
31480	8" x 8" Shingles	Steel	32	100/BDL
31482	8" x 8" Shingles with Crimp (4" x 4" x 8")	Aluminum	.017	100/CTN
31482	8" x 8" Shingles with Crimp (4" x 4" x 8")	Aluminum	.012	100/CTN
31484	8" x 8" Shingles with Crimp (4" x 4" x 8")	Aluminum	.012	500/CTN
31482	8" x 8" Shingles with Crimp (4" x 4" x 8")	Steel	29	100/CTN
31482	8" x 8" Shingles with Crimp (4" x 4" x 8")	Steel	32	100/CTN
31479	8" x 8" Shingles with Crimp (4" x 4" x 8")	Steel	34	100/CTN
31477	8" x 8" Shingles with Crimp (4" x 4" x 8")	Steel	34	100/BDL
31473	8" x 8" Shingles with Crimp (4" x 4" x 8")	Steel	34	50/CTN
31476	8" x 8" Shingles with Crimp (4" x 4" x 8")	Steel	32	50/BDL
31526	9-3/4" x 14" Shingles with Crimp (3-7/8" x 5-7/8" x 14")	Steel	26	20/BDL
31508	10" x 12" Shingles with Crimp (4" x 6" x 12")	Steel	32	100/BDL
31509	10" x 12" Shingles with Crimp (6" x 6" x 10")	Steel	32	100/BDL
31519	10" x 12" Shingles with Crimp (4" x 6" x 12")	Steel	34	100/BDL
31487	10" x 7" Shingles with Crimp (5" x 5" x 7")	Steel	34	100/CTN
31532	10" x 7" Shingles with Crimp (5" x 5" x 7")	Aluminum	.012	100/CTN
31489	10" x 8" Shingles with Crimp (5" x 5" x 8")	Aluminum	.012	500/CTN
31518	12" x 8" Shingles with Crimp (4" x 8" x 8")	Aluminum	.012	100/CTN
31545	Kick-Out Flashing LH (4" x 4" x 8" Crimped)	Steel	34	25/CTN
31544	Kick-Out Flashing RH (4" x 4" x 8" Crimped)	Steel	34	25/CTN



KLAUER

MANUFACTURING CO.

**Adding Strength
to Every Foundation.**

1185 Roosevelt Ext.
Dubuque, IA 52001

(563) 582.7201

smsales@klauer.com

WWW.KLAUER.COM

75960 Flashing Section

75961 Full Catalog

©2025 Klauer Manufacturing Company.